

# Gamma Spectrum Features

02/04/2011

# Contents

## Introduction

- Pulse Size
- Origin of Photons
- A Perfect World
- The Real World
- The Fundamental Issue

## Photons Come Directly from the Source

- Photoelectric Effect - Photopeak
- Photoelectric Effect – X-ray Escape Peak
- Compton Scattering – Compton Continuum
- Pair Production – Double and Single Escape Peaks

## Photons Interactions in the Shield

- General
- Photoelectric Effect – X-rays
- Photoelectric Effect – Graded Shield
- Compton Scattering – Backscatter Peak
- Pair Production – Annihilation Peak

# Contents

## Coincidence Summing

General – Sum Peak

Two Types of Coincidence

Two Problems with Coincidence Summing

True Coincidence

Random Coincidence

## Bremsstrahlung

General

## Shielded Spectra

General

Potential Changes to Spectrum

Heavily Shielded Spectrum

Shielded Ra-226 Spectrum

Improving a Shielded Spectrum

Self-shielded Sample

## Summary

# Introduction

9/23/09

# Introduction

## Pulse Size

- The size of a pulse (determined by the energy absorbed in the detector) depends on the:
  - photon energy
  - type of interaction in the detector: Photoelectric effect  
Compton scattering  
Pair production

# Introduction

## Origin of Photons

- The photons that interact in the detector are:
  - coming directly from the source being analyzed
  - secondary radiation generated in materials other than the detector (especially the shield)
  - background radiation (e.g., K-40's 1461 keV gammas)

# Introduction

## A Perfect World

- In a perfect world, pulses that contribute to the spectrum would only be due to photons:
  - coming directly from the source being analyzed (do not interact before reaching the detector)
  - interacting in the detector so that all their energy is absorbed (primarily via the photoelectric effect).
  - interact singly, i.e. two photons should not interact in the detector at the same time (in coincidence)
- That this does not happen in the real world is indicated on the next two slides.

# Introduction

## The Real World

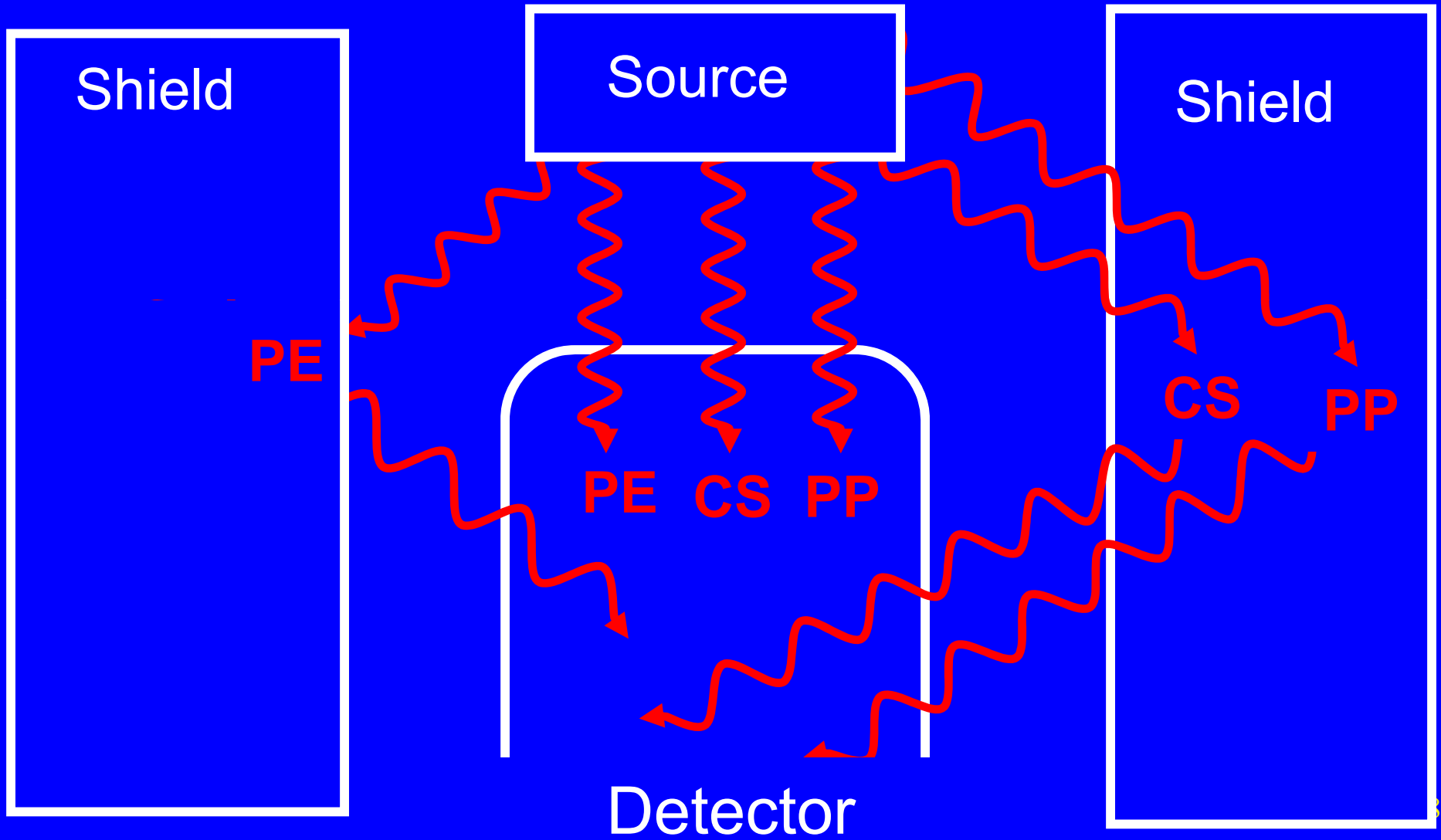



# Introduction

## The Real World

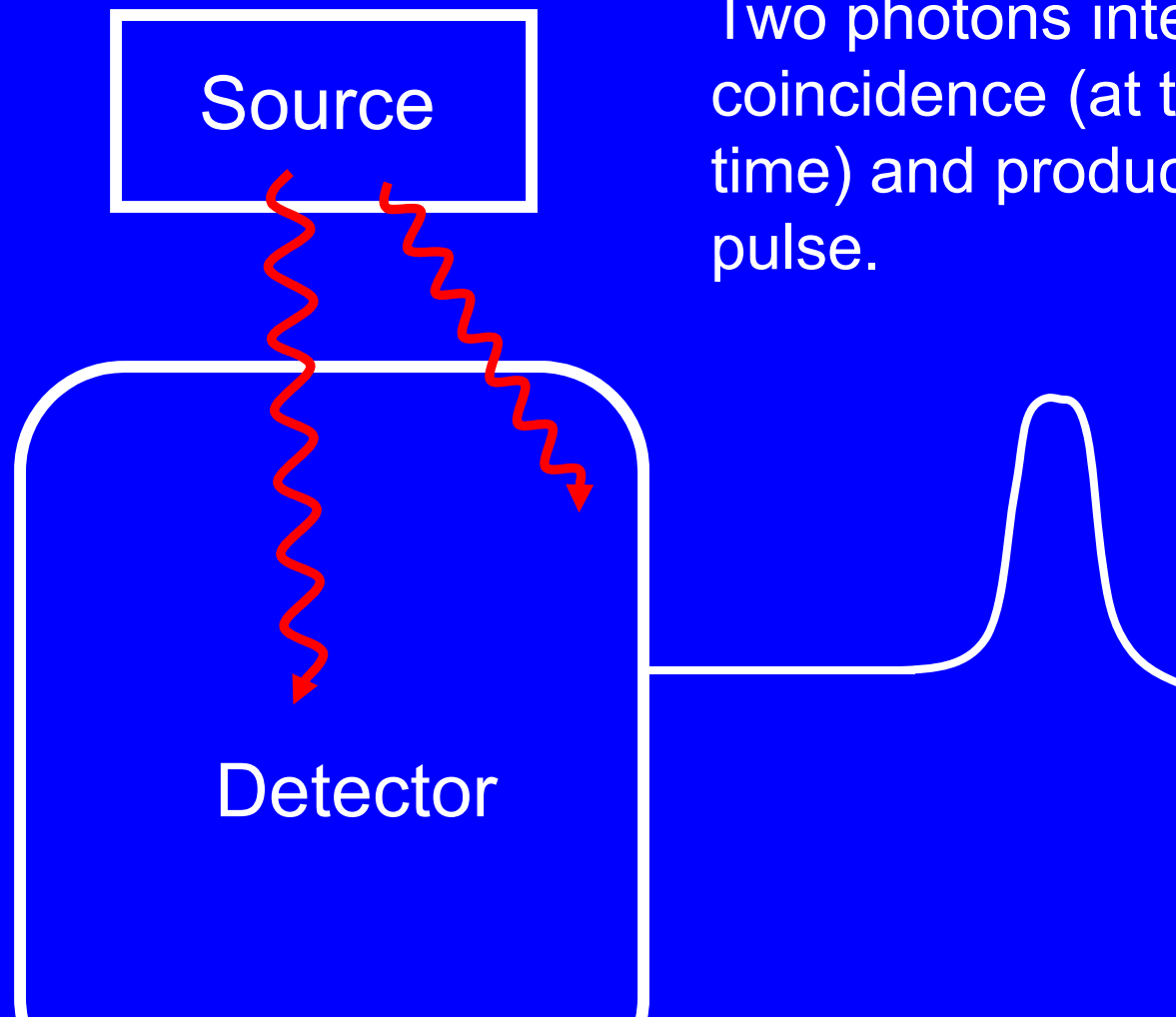

Two photons interact in coincidence (at the same time) and produce a single pulse.

# Introduction

## Fundamental Issue

- What impact do the preceding phenomena have on the spectrum?

Photons Coming Directly from the  
Source Interact in the Detector

# Photons Come Directly from Source

## Photoelectric Effect - Photopeak

- If you ruled the world, the only thing you would allow:  
Photons coming directly from the source interact in the detector via the photoelectric effect so that all their energy is deposited in the detector.  
If this happens repeatedly, a number of pulses of similar size will be produced.
- The result on the spectrum is the **photopeak** (aka full energy peak or total absorption peak)

# Photons Come Directly from Source

## Photoelectric Effect - Photopeak

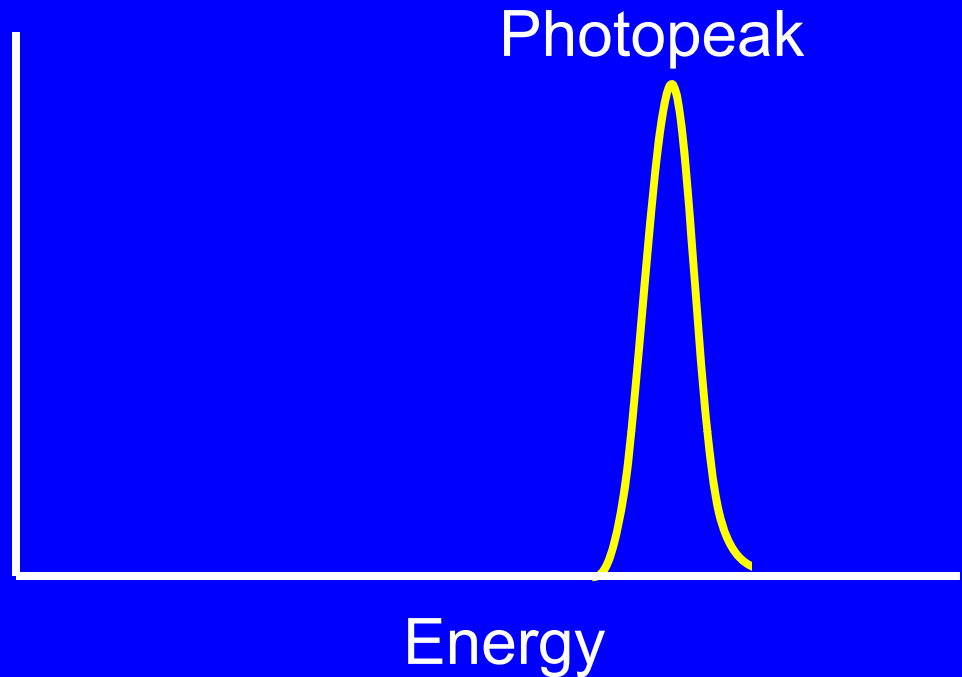
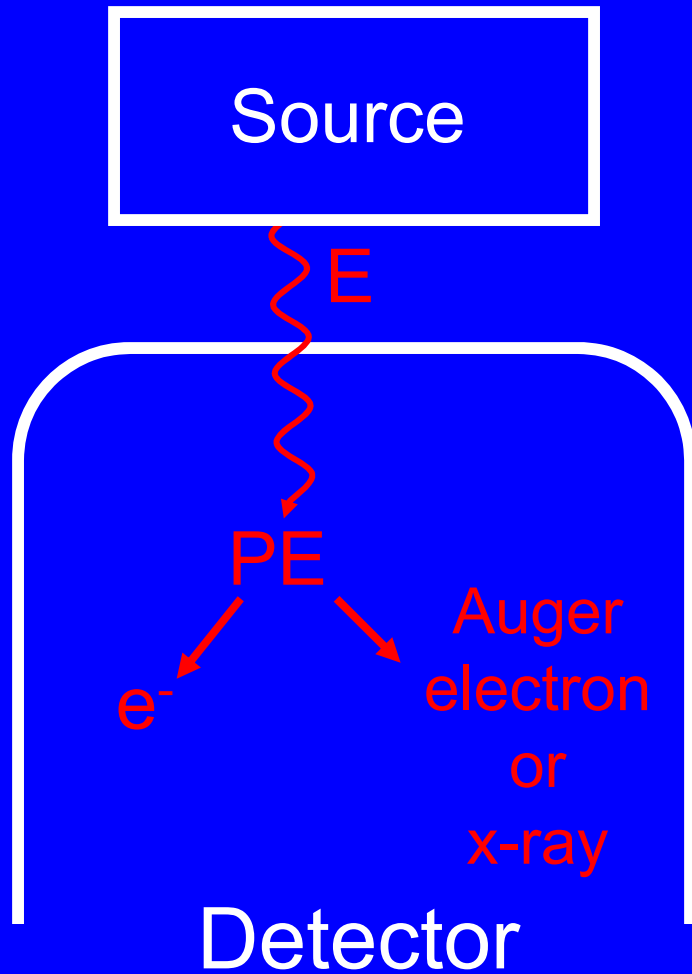

Gamma-ray photon deposits all of its energy ( $E$ ) in detector.

Result: **Photopeak**

# Photons Come Directly from Source

## Photoelectric Effect - Photopeak

- In the photoelectric effect, most of the photon's energy is given to the photoelectron. The latter only travels a very short distance (e.g., less than a mm) before it gives up all its energy to the detector.
- In addition, somewhat less energy is carried off by an x-ray or auger electron.

In most situations, this energy is deposited in the detector - either the x-ray or Auger electron are completely absorbed.

# Photons Come Directly from Source

## Photoelectric Effect – X-ray Escape Peak

- However, if the photoelectric interaction was near the detector surface and the x-ray heads in the right direction, the x-rays might escape the detector.
- If this happens repeatedly, what is known as an **X-ray escape peak appears** on the spectrum to the left of the photopeak.
- X-ray escape peaks are most likely with:
  - low energy gamma rays (e.g., less than 100 keV)
  - small detectors.

# Photons Come Directly from Source

## Photoelectric Effect – X-ray Escape Peak

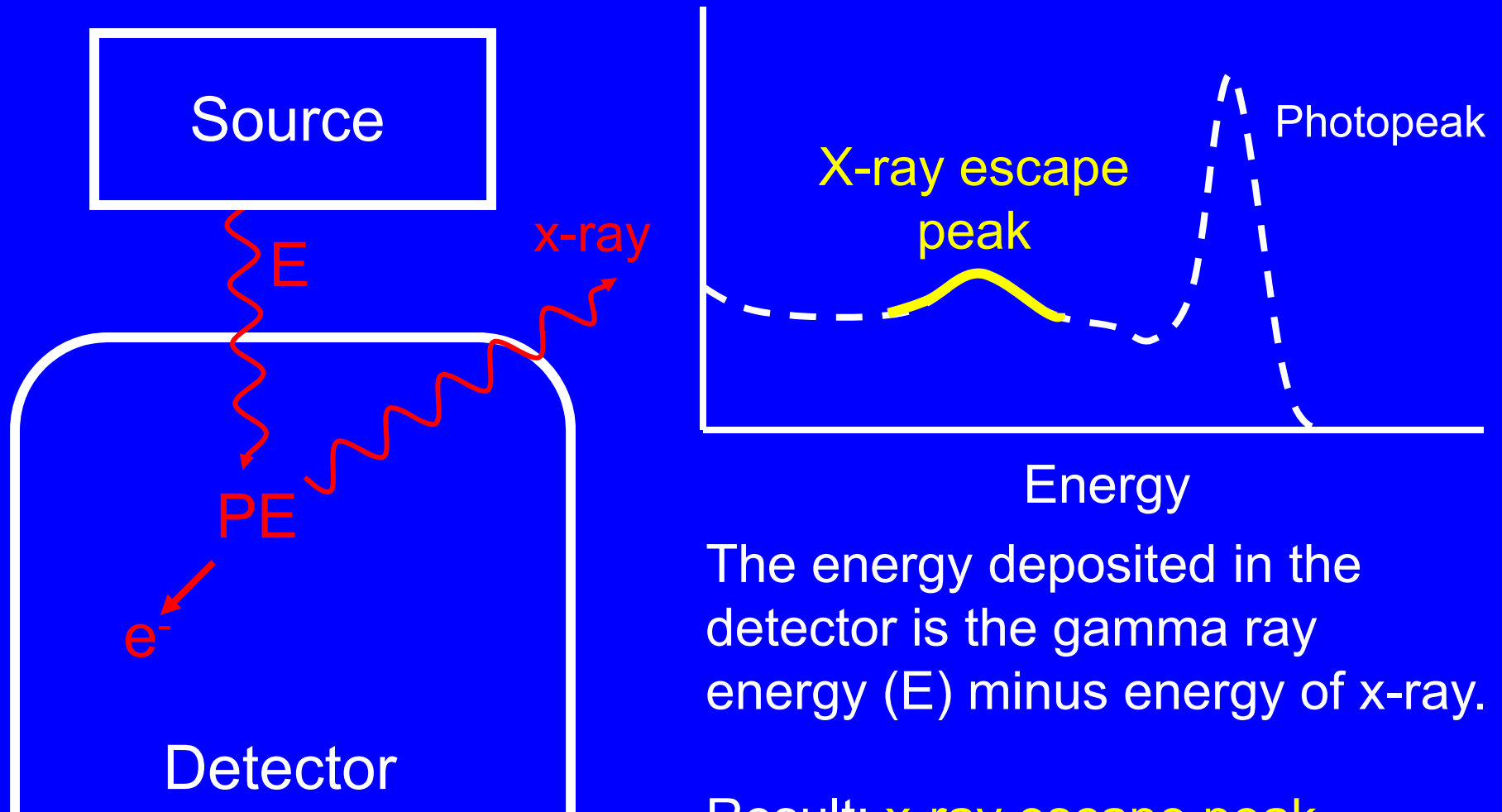

The energy deposited in the detector is the gamma ray energy ( $E$ ) minus energy of x-ray.

Result: **x-ray escape peak**



# Photons Come Directly from Source

## Photoelectric Effect – X-ray Escape Peak

- The energy of the x-ray escape peak energy would be the gamma ray minus the x-ray energy.
- With a NaI detector, the x-ray escape peak would be roughly 30 keV below the photopeak.
- With a HPGe detector, the x-ray escape peak is approximately 10 keV below the photopeak.
- Keep in mind: The energy deposited in the detector is the energy that goes in (the photon energy) minus the energy that leaves the detector.

# Photons Come Directly from Source

## Compton Scattering – Compton Continuum

- Now we consider the situation where the photon interacts in the detector (once) via Compton scattering and leaves the detector.
- The energy deposited in the detector varies according to the angle of scatter.

Small pulses are produced when the angle of scatter is small (e.g., 10 degrees).

The largest pulses are produced when the angle of scatter is 180 degrees. Even then, the pulses are smaller than those that contribute to the photopeak.

# Photons Come Directly from Source

## Compton Scattering – Compton Continuum

- The result on the spectrum is the **Compton continuum** - a range of pulses to the left of the photopeak that carry almost no useful information.
- The largest pulses in the Compton continuum form the **Compton edge**.

They are produced when the angle of the scattered gamma ray is 180 degrees.

Photons scattered at 180 degrees frequently have energies close to 200 keV.

As such, the Compton edge is usually 200 keV to the left of the photopeak.

# Photons Come Directly from Source

## Compton Scattering – Compton Continuum

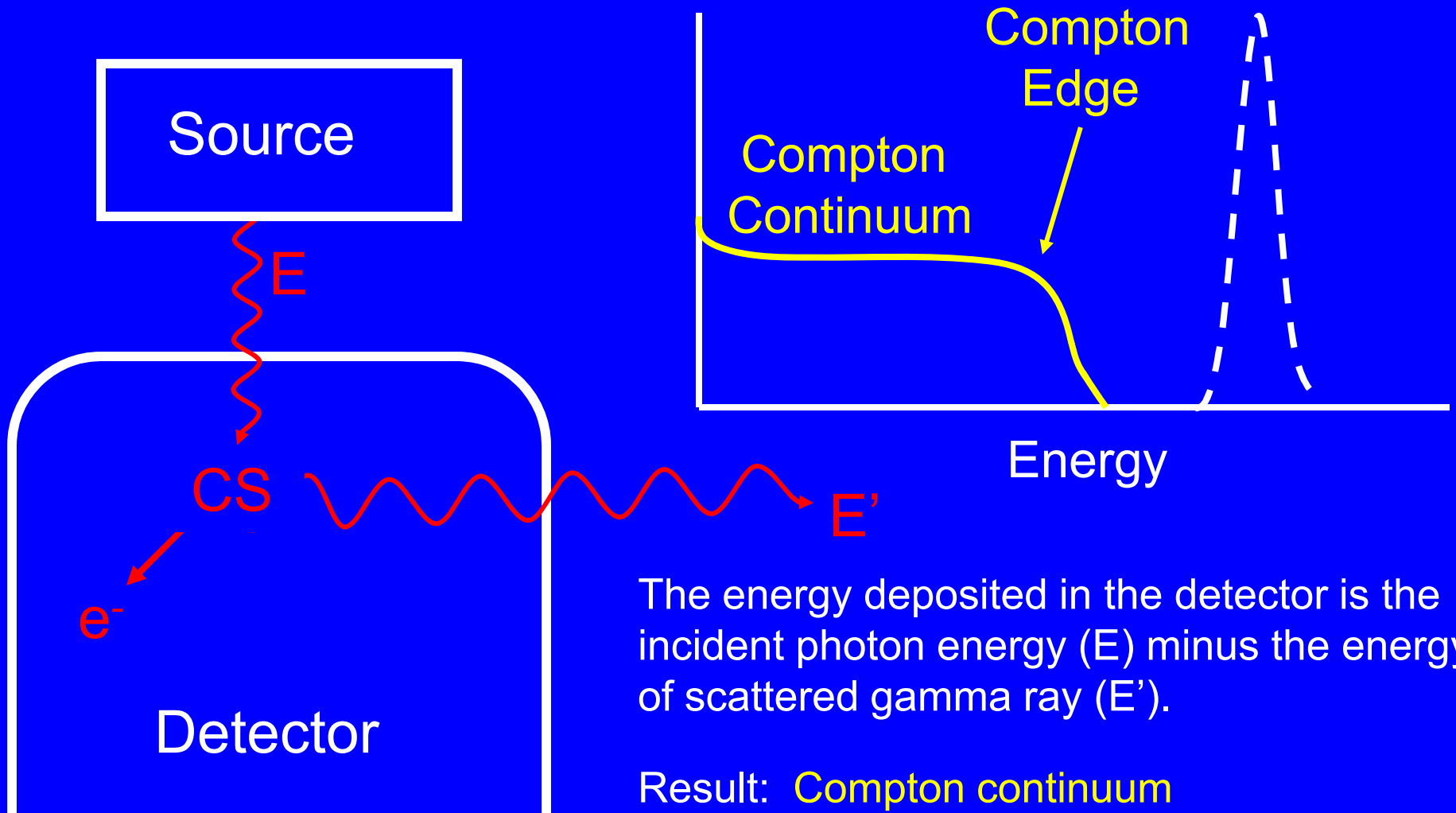

The energy deposited in the detector is the incident photon energy ( $E$ ) minus the energy of scattered gamma ray ( $E'$ ).

Result: **Compton continuum**

# Photons Come Directly from Source

## Compton Scattering – Compton Continuum

- Each photopeak has its own Compton Continuum
- The lower the photon energy:
  - The closer the Compton edge is to the photopeak
  - The smaller the Compton continuum is with respect to the photopeak
- The exact position of the Compton edge can be somewhat uncertain because some of the pulses near the edge are due to photons scattering more than once.

# Photons Come Directly from Source

## Compton Scattering – Compton Continuum

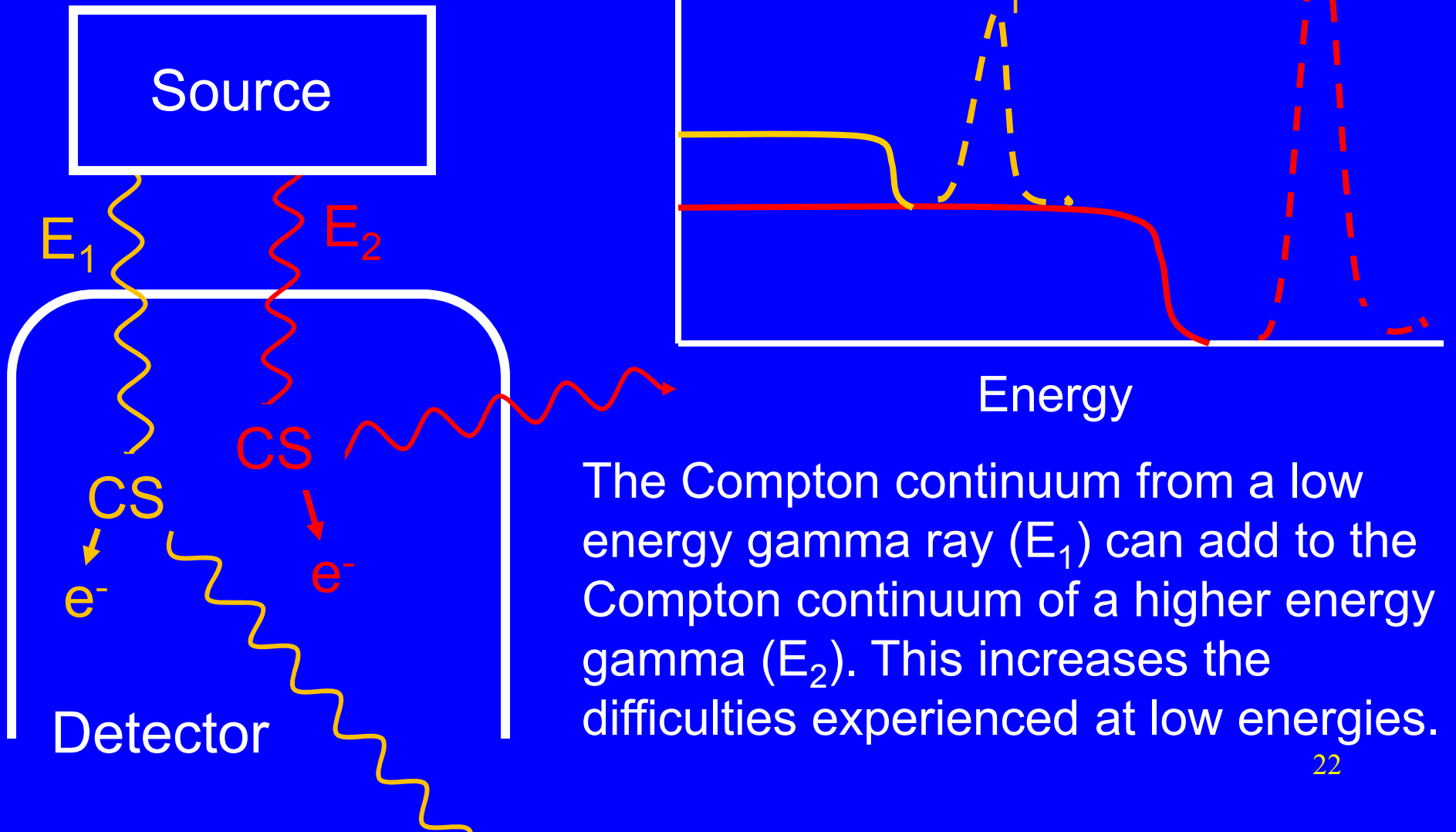

The Compton continuum from a low energy gamma ray ( $E_1$ ) can add to the Compton continuum of a higher energy gamma ( $E_2$ ). This increases the difficulties experienced at low energies.

# Photons Come Directly from Source

## Pair Production – Double and Single Escape Peaks

- Pair production is only possible for photons with energies greater than 1022 keV.
- If the gamma rays interact in the detector via pair production so that both 511 keV annihilation photons escape the detector, the energy deposited in the detector is the original gamma ray energy minus 1022 keV.
- If this happens often enough, a double escape (DE) peak appears on the spectrum.
- The double escape peak is 1022 keV below the photopeak energy.

# Photons Come Directly from Source

## Pair Production – Double and Single Escape Peaks

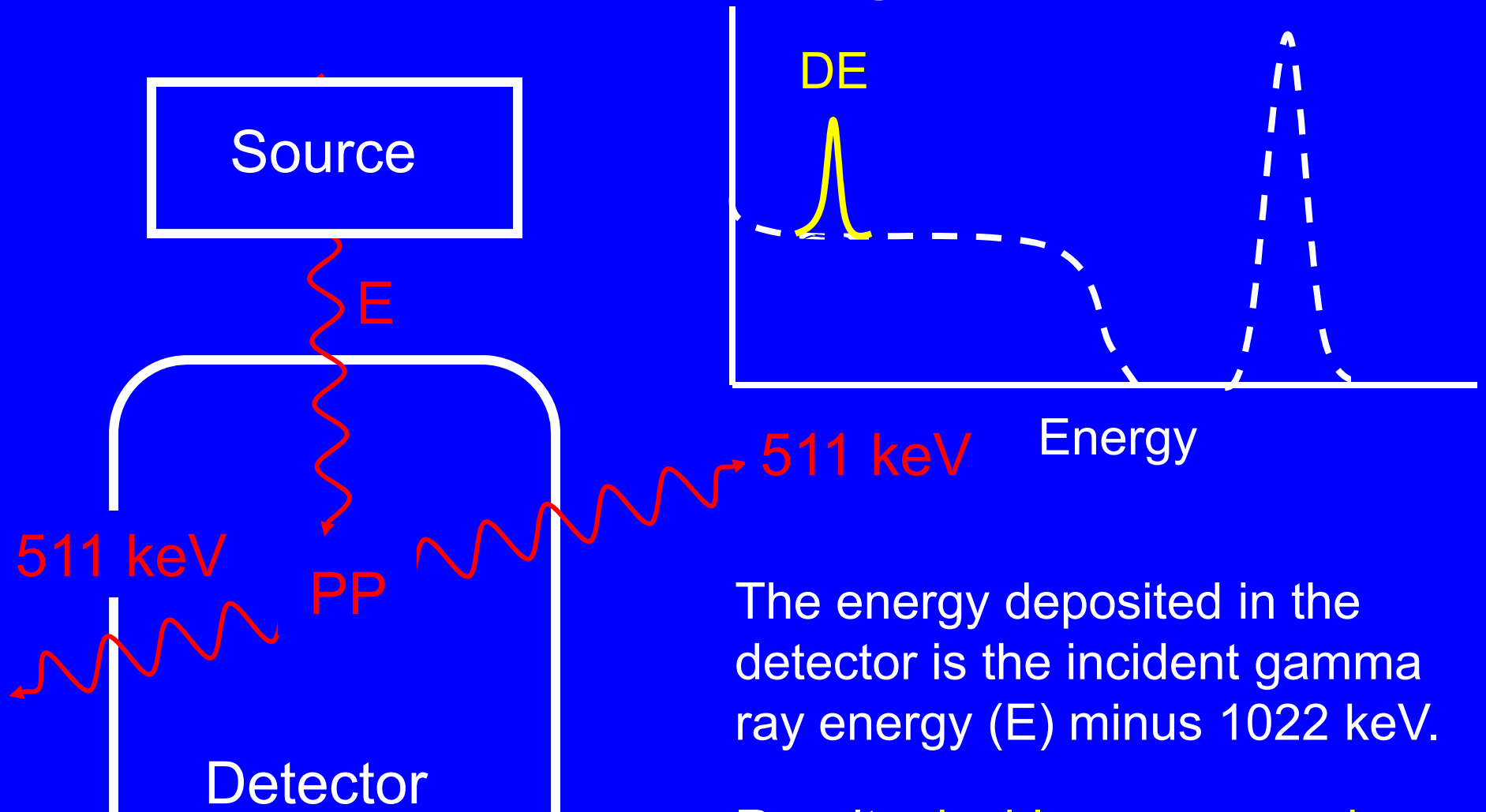

The energy deposited in the detector is the incident gamma ray energy ( $E$ ) minus  $1022 \text{ keV}$ .

Result: **double escape peak**<sub>24</sub>



# Photons Come Directly from Source

## Pair Production – Double and Single Escape Peaks

- If the gamma rays interact in the detector via pair production so that one 511 keV annihilation photon escapes the detector, the energy deposited is the original gamma ray energy minus 511 keV.
- If this happens often enough, a single escape (SE) peak appears on the spectrum.
- The single escape peak is 511 keV below the photopeak energy.

# Photons Come Directly from Source

## Pair Production – Double and Single Escape Peaks

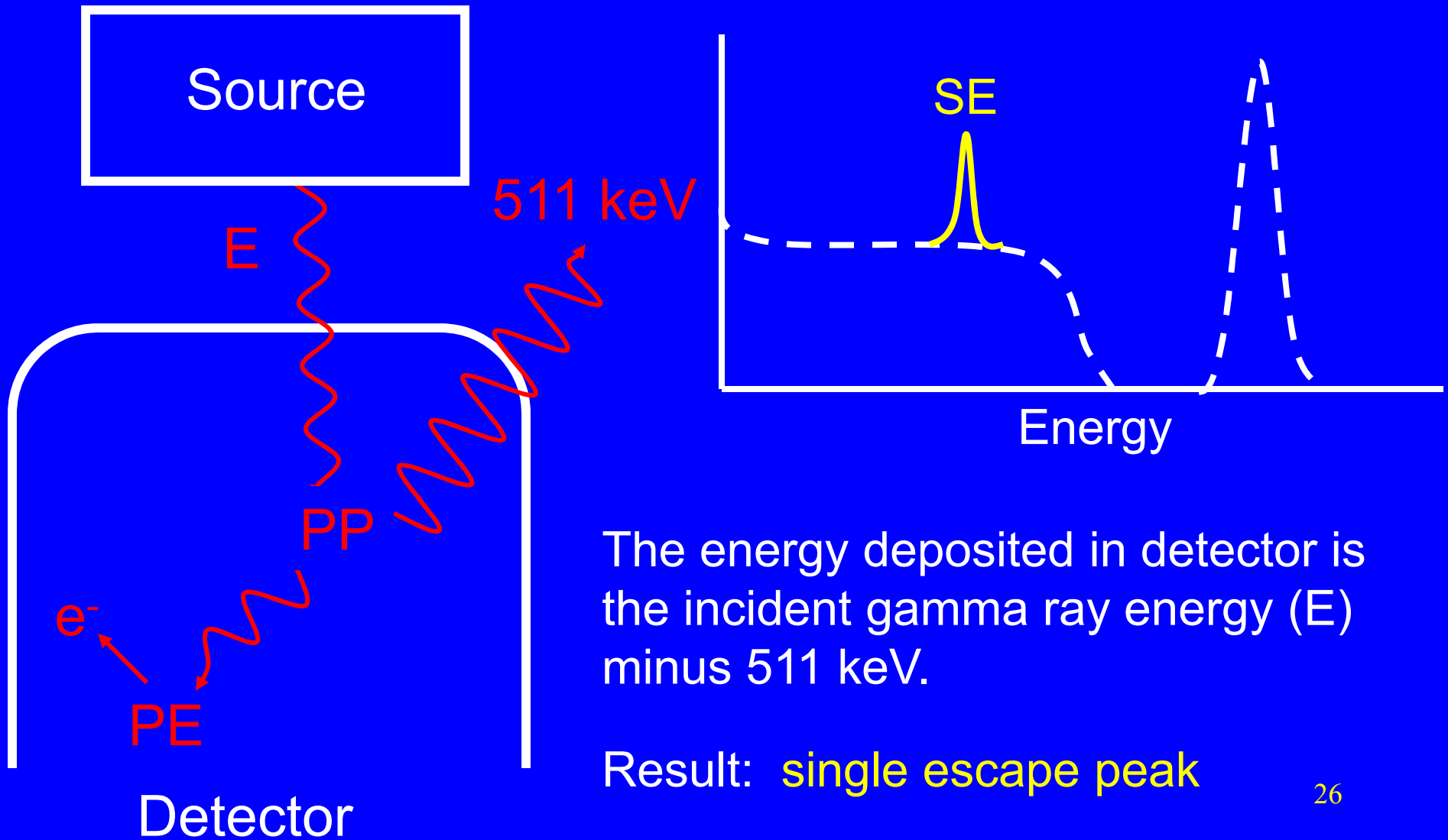

# Photons Come Directly from Source

## Pair Production – Double and Single Escape Peaks

- If the gamma rays is of very high energy, it might not be seen on the spectrum even though the escape peaks might be seen!

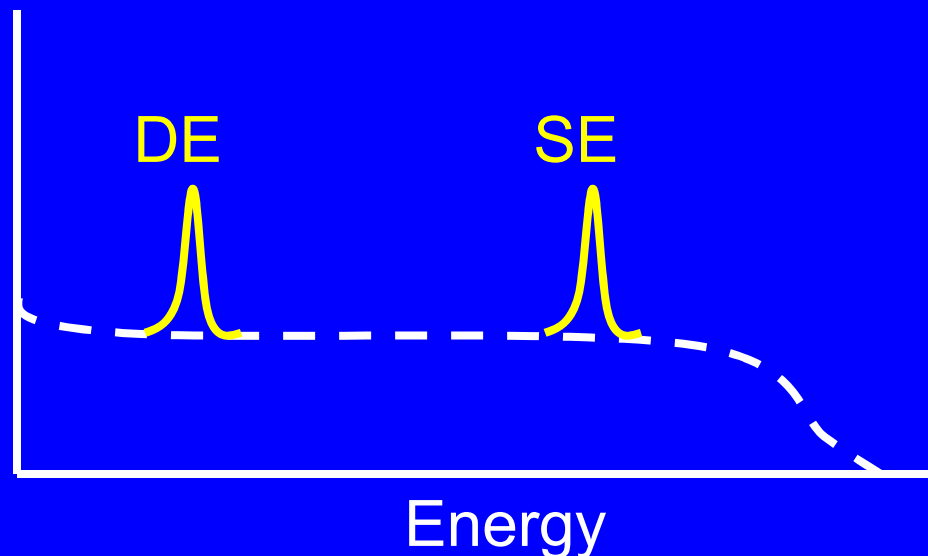

Photons Interact in the Shield  
and Produce Secondary  
Radiation that Interacts in the  
Detector

# Photons Interactions in the Shield

## General

- Photons from the source (or background) can interact in materials other than the detector.
- Most such interactions near the detector are in the shield. The latter is relatively massive and has a high atomic number.
- These interactions generate different types of secondary radiation that the detector will respond to.

# Photons Interactions in the Shield

## Photoelectric Effect – Characteristic X-rays

- Following photoelectric interactions in the shield, characteristic x-rays can be produced.
- Their energies are characteristic of the element in which the interaction took place.
- Depending on the design of the shield, the peaks for these x-rays might be seen on the spectrum.
- In the case of a lead shield, these peaks would be at 73, 75, 85 and 87 keV.
- Of these, the 75 keV peak is the largest and possibly the only one that might be seen.

# Photons Interactions in the Shield

## Photoelectric Effect – Characteristic X-rays

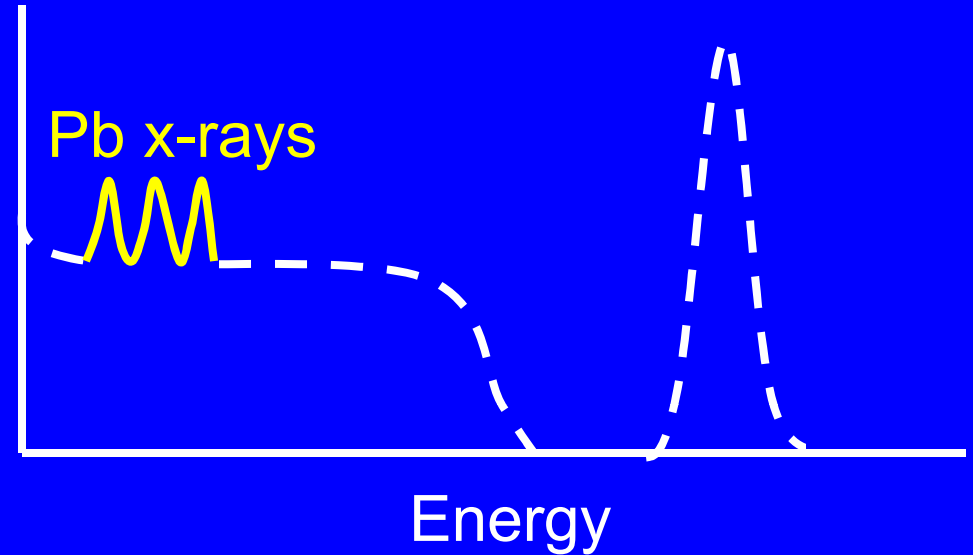
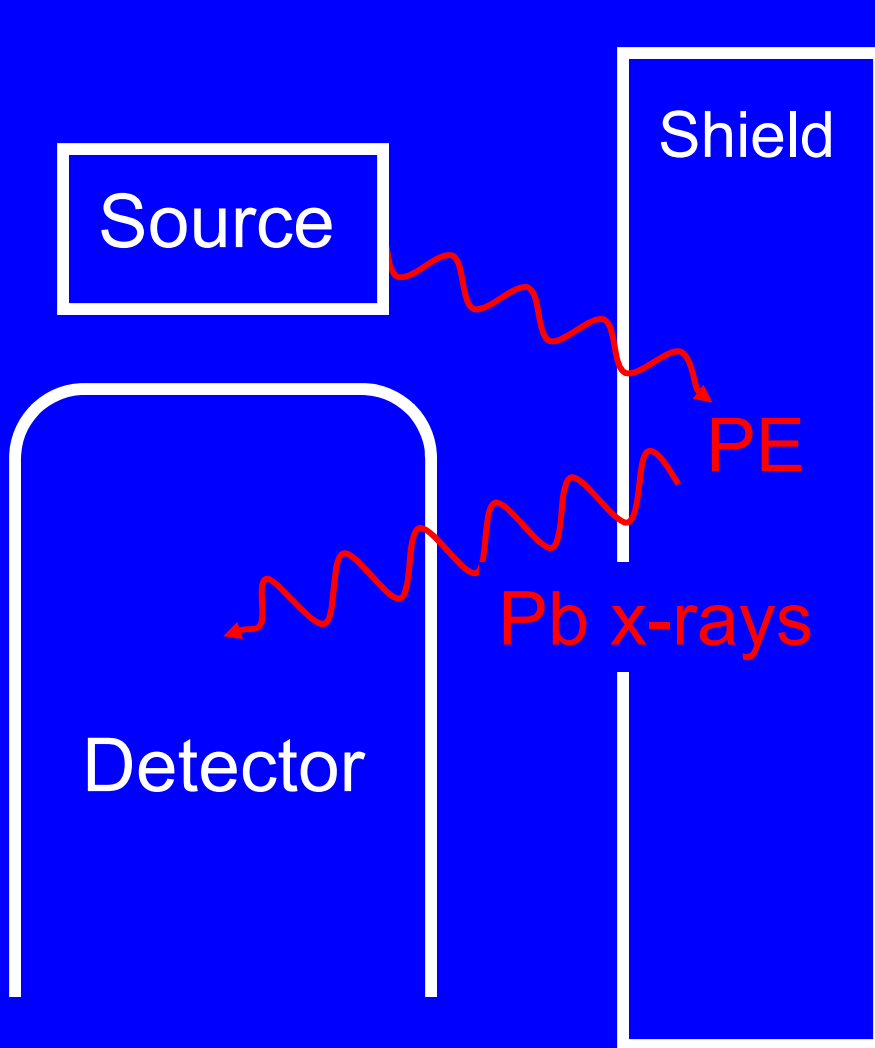

If these x-rays penetrate the detector housing, they will likely deposit all their energy in the detector.

Result: **lead x-ray peaks** 31

# Photons Interactions in the Shield

## Photoelectric Effect – Graded Shield

- The lead x-ray peaks can be eliminated by the use of a graded shield.
- A graded shield has a thin sheet (ca. 1 mm) of cadmium or a material with a similar atomic number lining the lead.

Inside the cadmium is a thin sheet of copper.

- The lead x-rays from the shield are stopped by the cadmium.

In the process, cadmium x-rays are produced. These in turn are stopped by the copper.

The resulting copper x-rays are of so low an energy that they do not get through the detector housing.



# Photons Interactions in the Shield

## Photoelectric Effect – Graded Shield

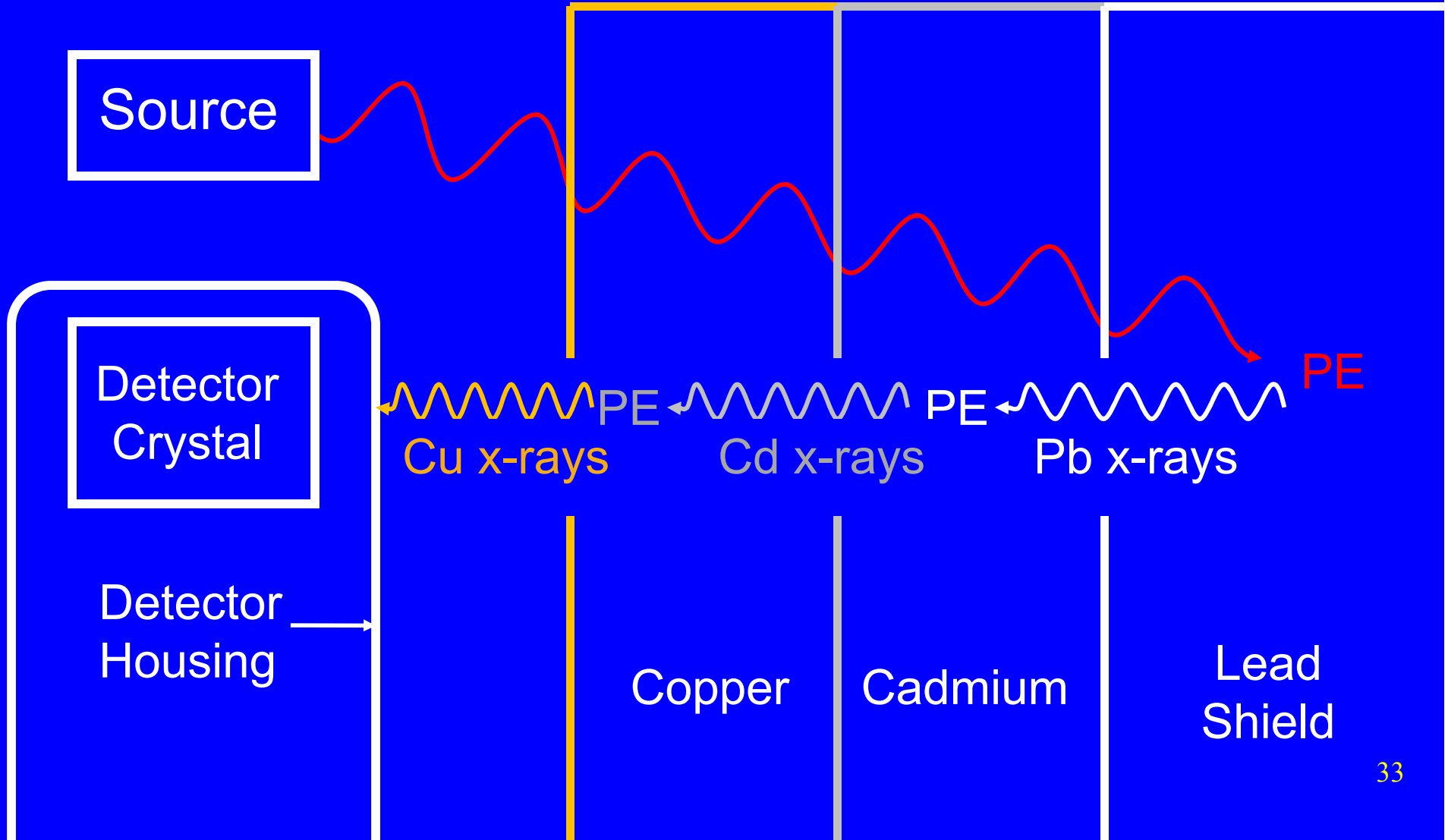

# Photons Interactions in the Shield

## Compton Scattering – Backscatter Peak

- Some of the gamma rays that undergo Compton scattering in the shield will be scattered back to the detector.
- Most of the scattered gamma rays seen by the detector scattered at an angle close to 180 degrees.
- The result on the spectrum is a “backscatter peak.”
- Except for very low energy photons, the backscatter peak is usually close to 200 keV.
- Unlike a “legitimate” peak, a backscatter peak is not symmetrical, it has a high energy tail. The latter is due to scattering at angles less than 180 degrees.

# Photons Interactions in the Shield

## Compton Scattering – Backscatter Peak

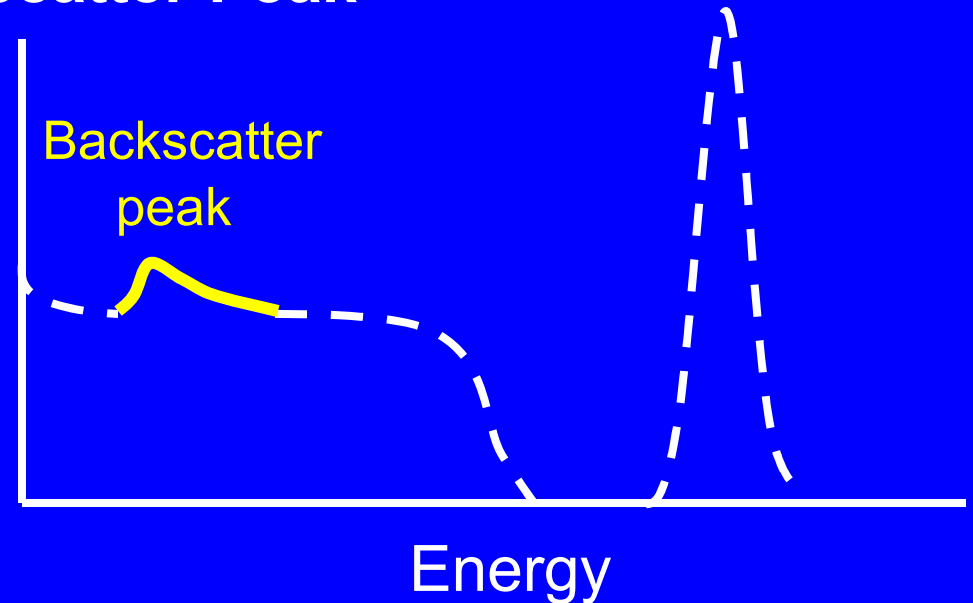
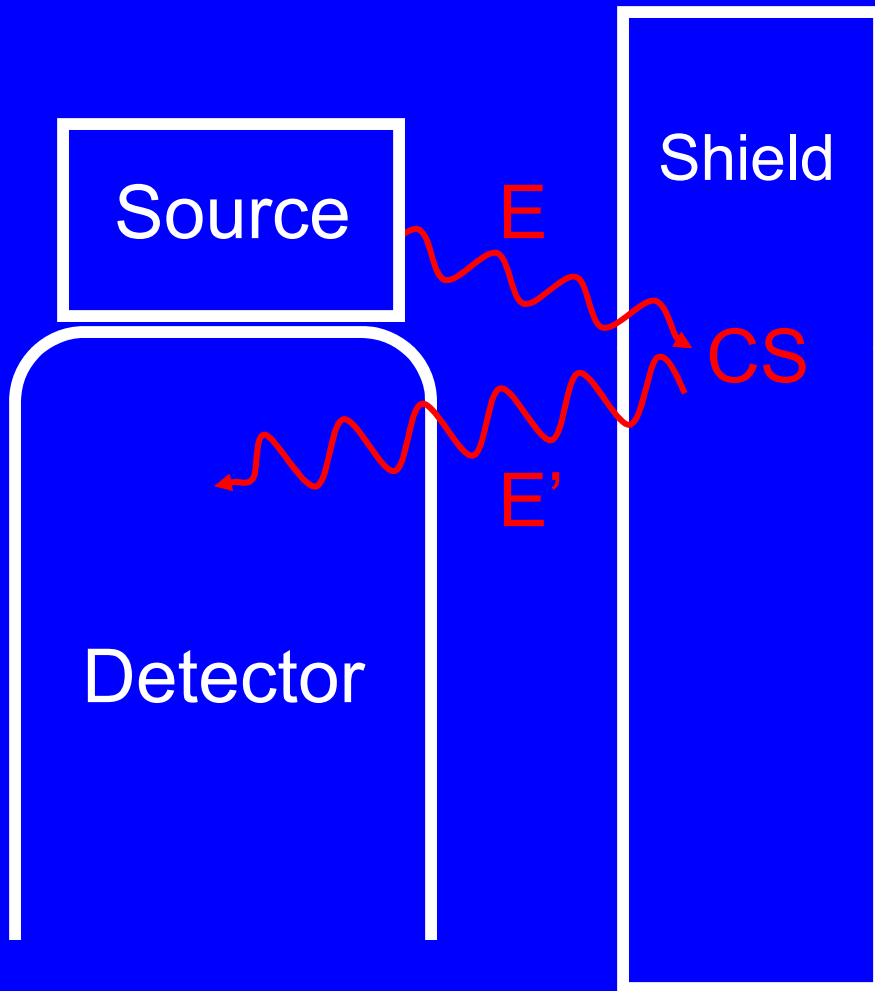

The energy deposited in the detector is the energy of the scattered gamma ray ( $E'$ ).

Result: **backscatter peak**

# Photons Interactions in the Shield

## Pair Production – Annihilation Peaks

- While pair production is only possible for photons with energies above 1022 keV, there are often such photons in background (e.g., the 1461 keV K-40 gamma rays).
- Following the pair production interactions,, some of the resulting 511 keV annihilation photons will be directed towards the detector.
- The result on the spectrum is an annihilation peak at 511 keV.

# Photons Interactions in the Shield

## Pair Production – Annihilation Peaks

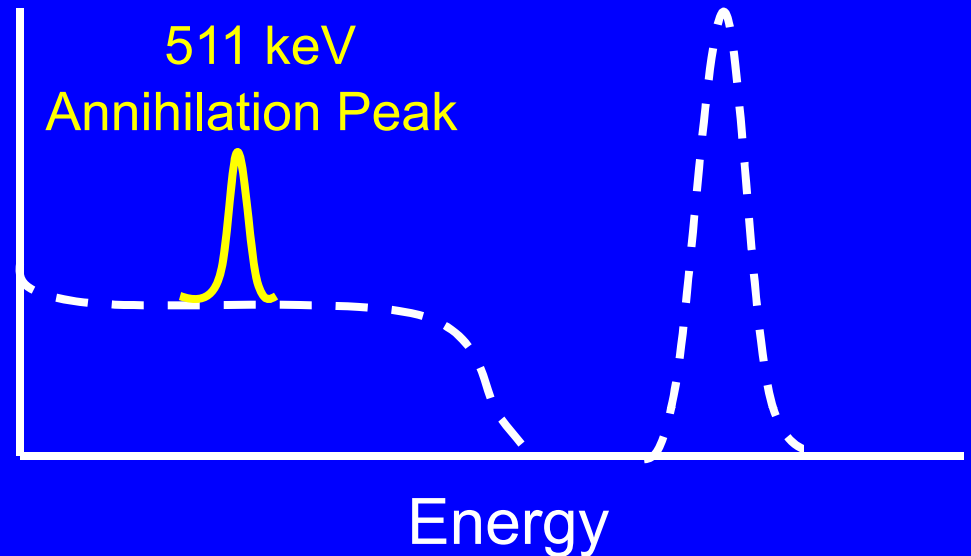
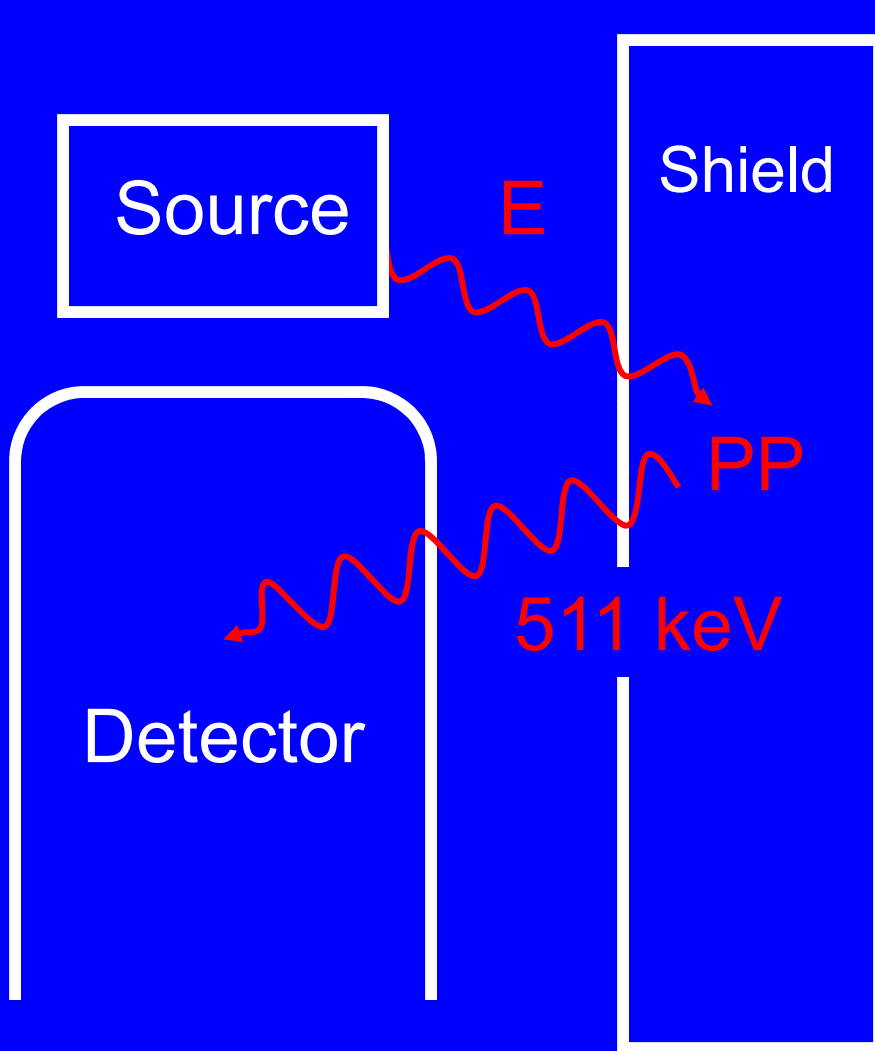

The energy deposited in detector is  $511 \text{ keV}$ .

Result: **Annihilation peak**

# Coincidence Summing

# Coincidence Summing

## General – Sum Peak

- When two or more photons (gamma rays or x-rays) interact in the detector at the same time, only one discernible pulse results.
- This is known as coincidence summing.
- The pulse size reflects the sum of the energies deposited by the two photons.
- If both photons interact via the photoelectric effect, and this happens with sufficient frequency, a summation (sum) peak appears on the spectrum.
- The energy attributed to the sum peak is the sum of the energies of the coincident photons.

# Coincidence Summing

## General – Sum Peak

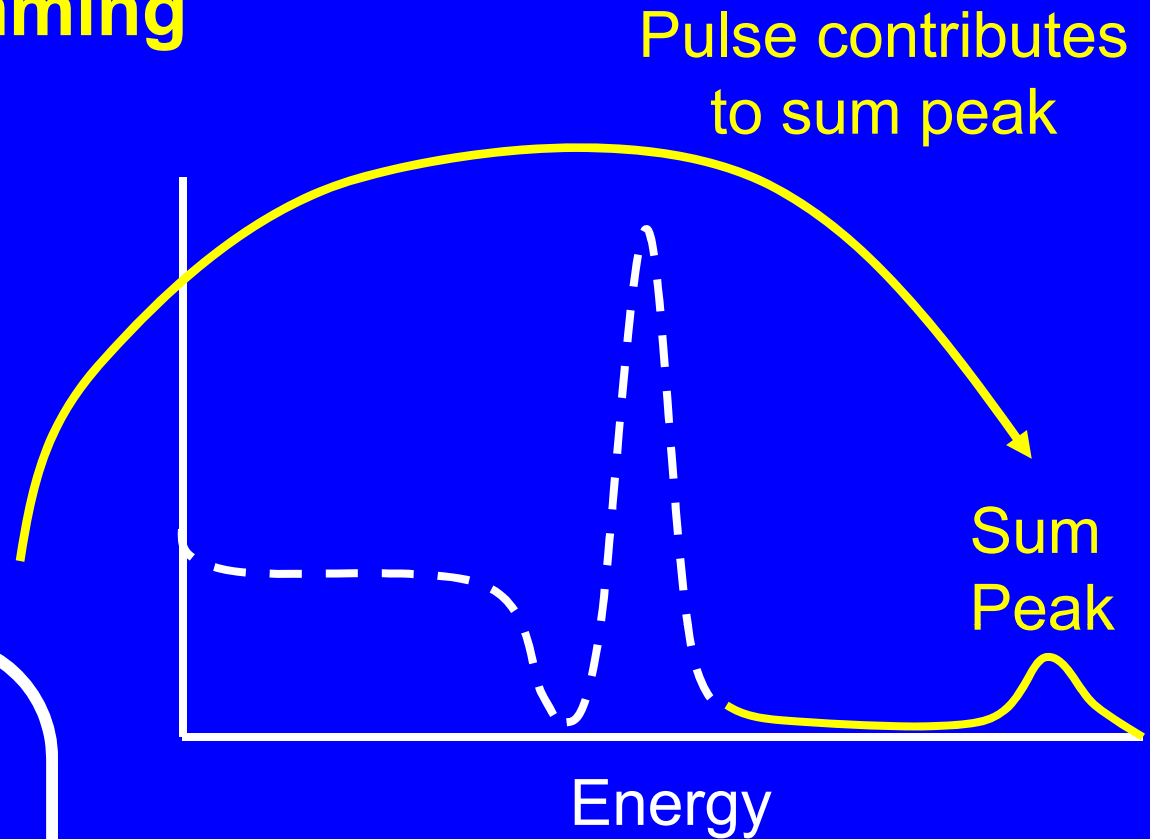
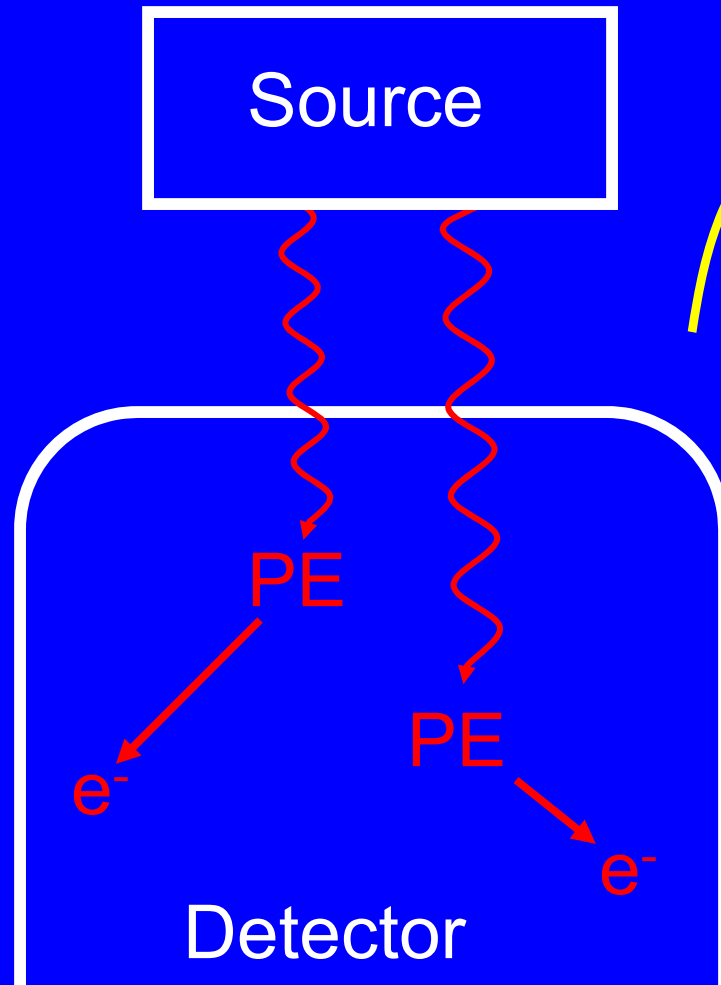

Two photons deposit all their energy ( $E + E$ ) in the detector in coincidence.

Result: **Sum peak**



# Coincidence Summing

## General – Sum Peak

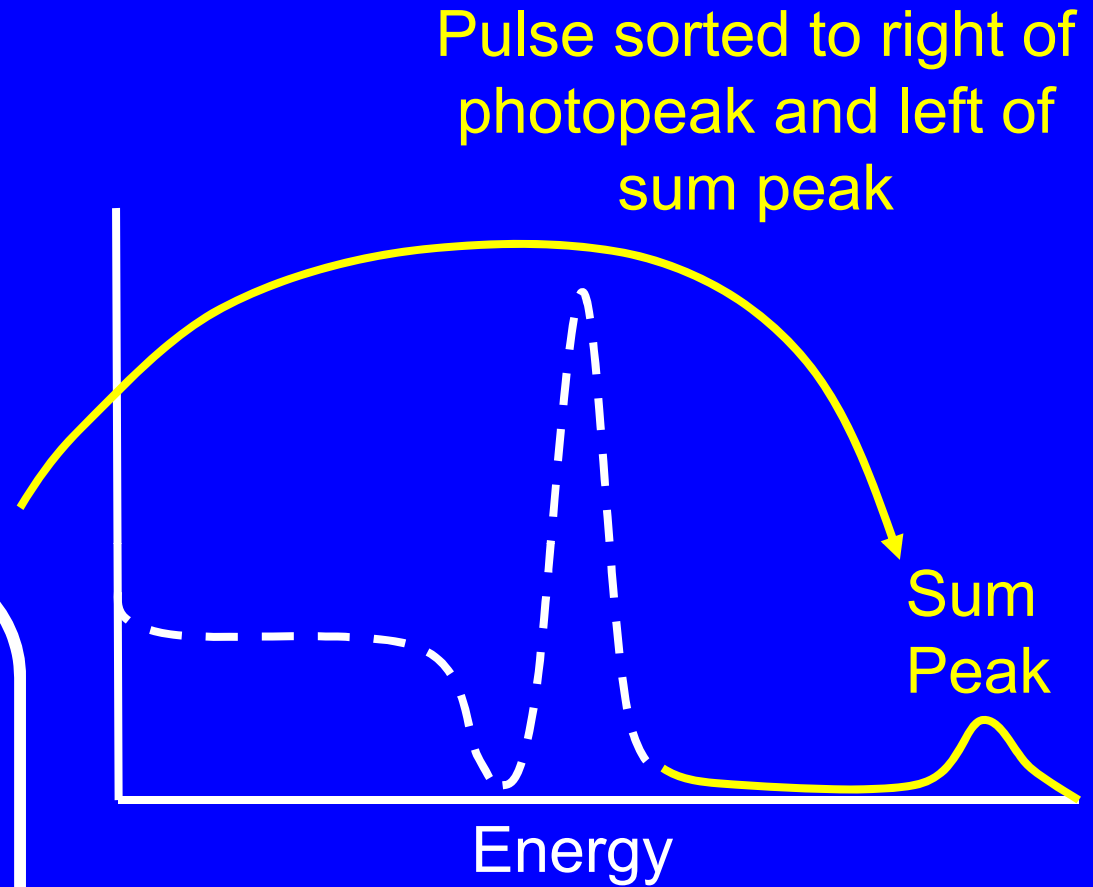
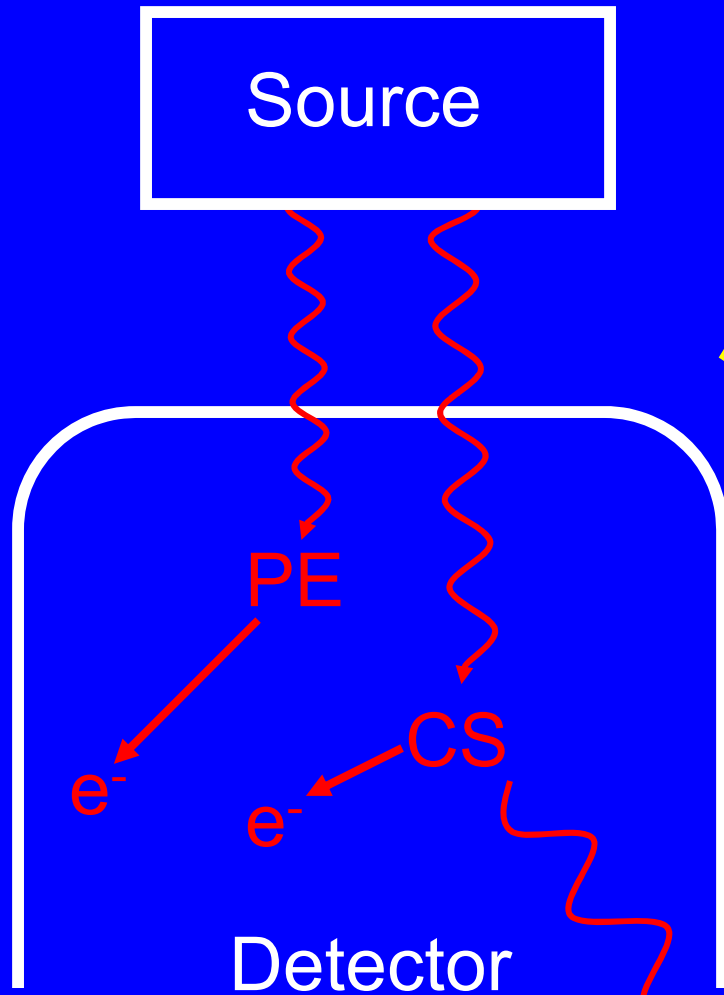

One photon deposited all its energy in the detector but the other photon didn't, it interacted via Compton scattering.

# Coincidence Summing

## Two Types of Coincidence Summing

- True coincidence
- Random (chance) coincidence

# Coincidence Summing

## Two Problems with Coincidence Summing

- Coincident summing can cause the production of one or more sum peaks.

These sum peaks might be misidentified.

- The more serious problem is that summation results in a loss of counts in the photopeak.

This loss of counts in the photopeak can lead to an underestimate of the sample activity.

# Coincidence Summing

## True Coincidence

- True coincidence occurs when the two coincident gamma rays were emitted during the decay of a single atom.
- True coincidence is only possible if a given radionuclide emits more than one gamma ray and that these photons are produced in the decay at the same time (in coincidence).
- In the case of Co-60, the 1173.2 and 1332.5 keV gamma rays are emitted at the same time.
- The resulting sum peak would be at 2505.7 keV.

# Coincidence Summing

## True Coincidence

- True coincidence is most likely when the sample is immediately adjacent to the detector.
- The count rate is irrelevant.
- The probability of true coincidence can be reduced by moving the sample farther from the detector.

This reduces the solid angle as seen on the next slide.

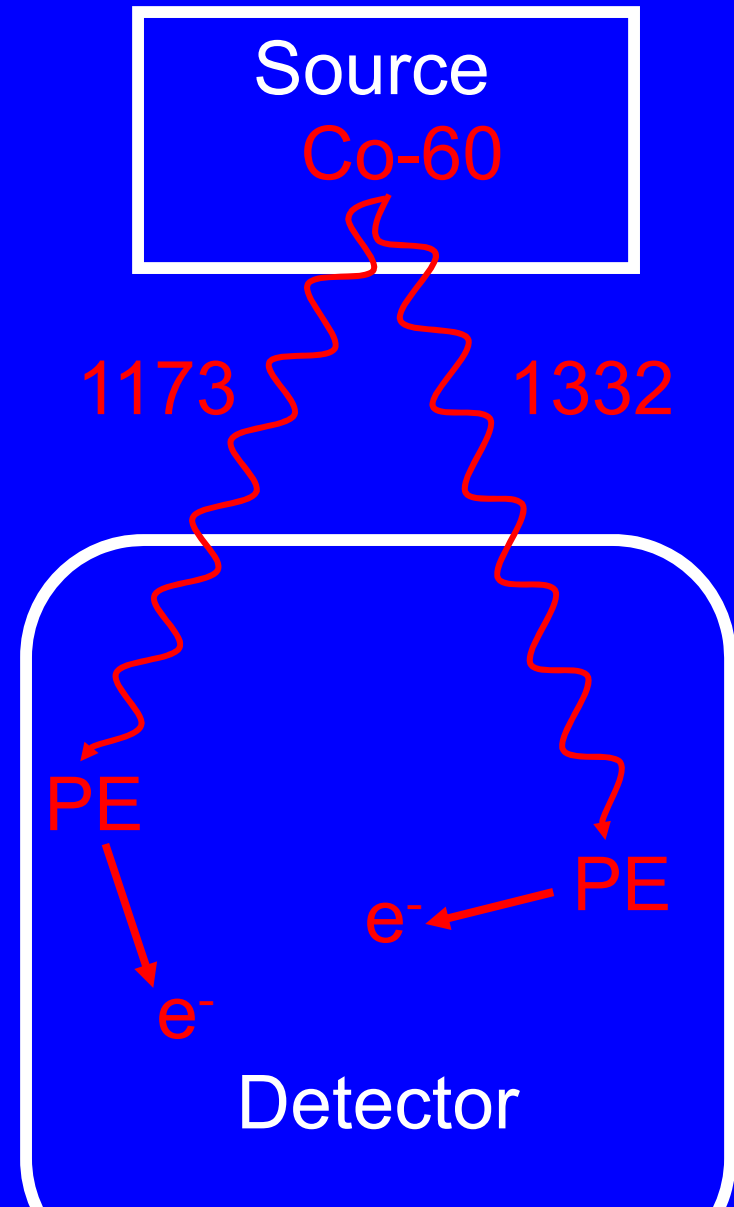

# Coincidence Summing

## True Coincidence

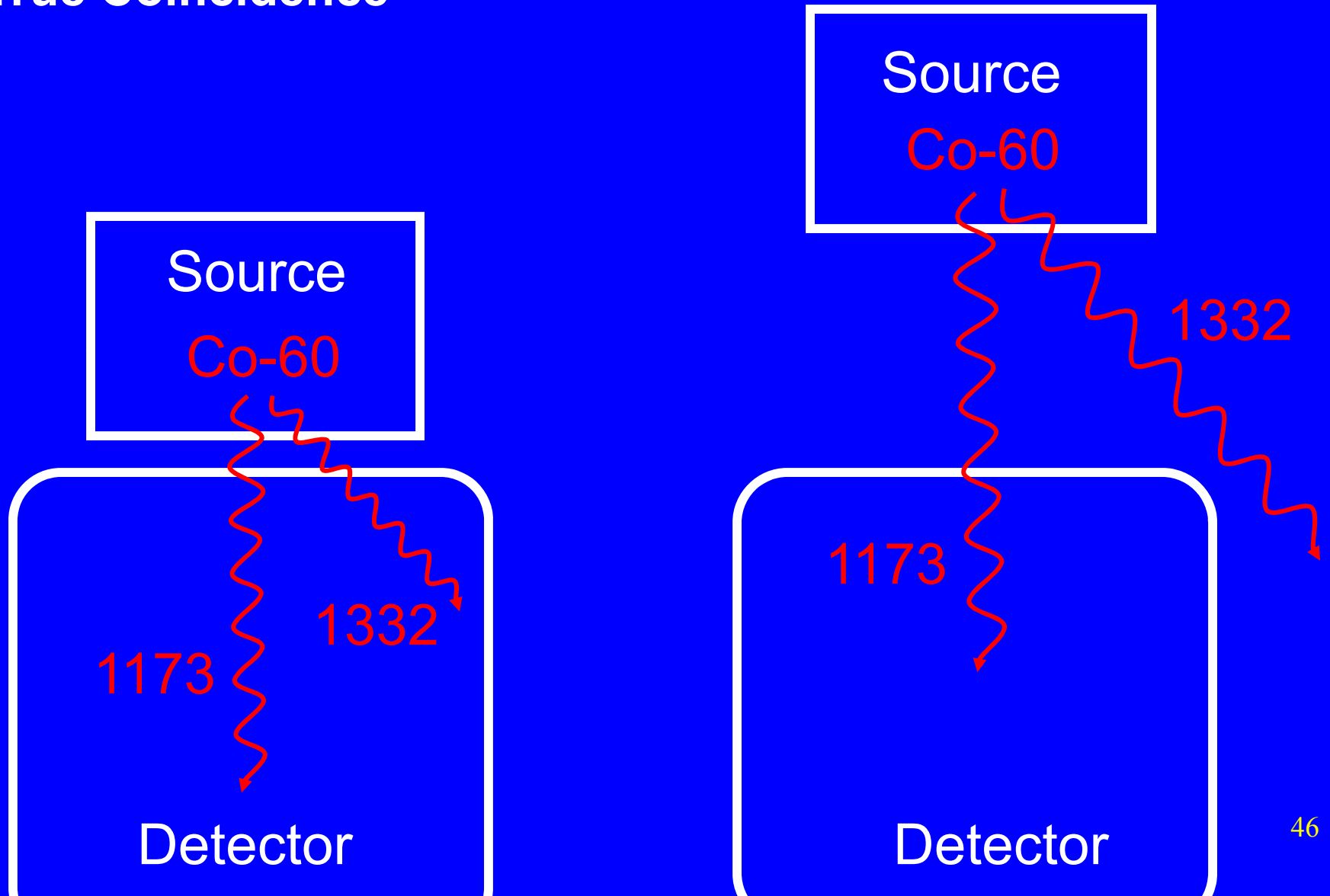

# Coincidence Summing

## True Coincidence

- Counting samples in a well detector significantly increases the probability of true coincidence.
- When using a well detector to identify radioactive material, the sample should be outside the well.

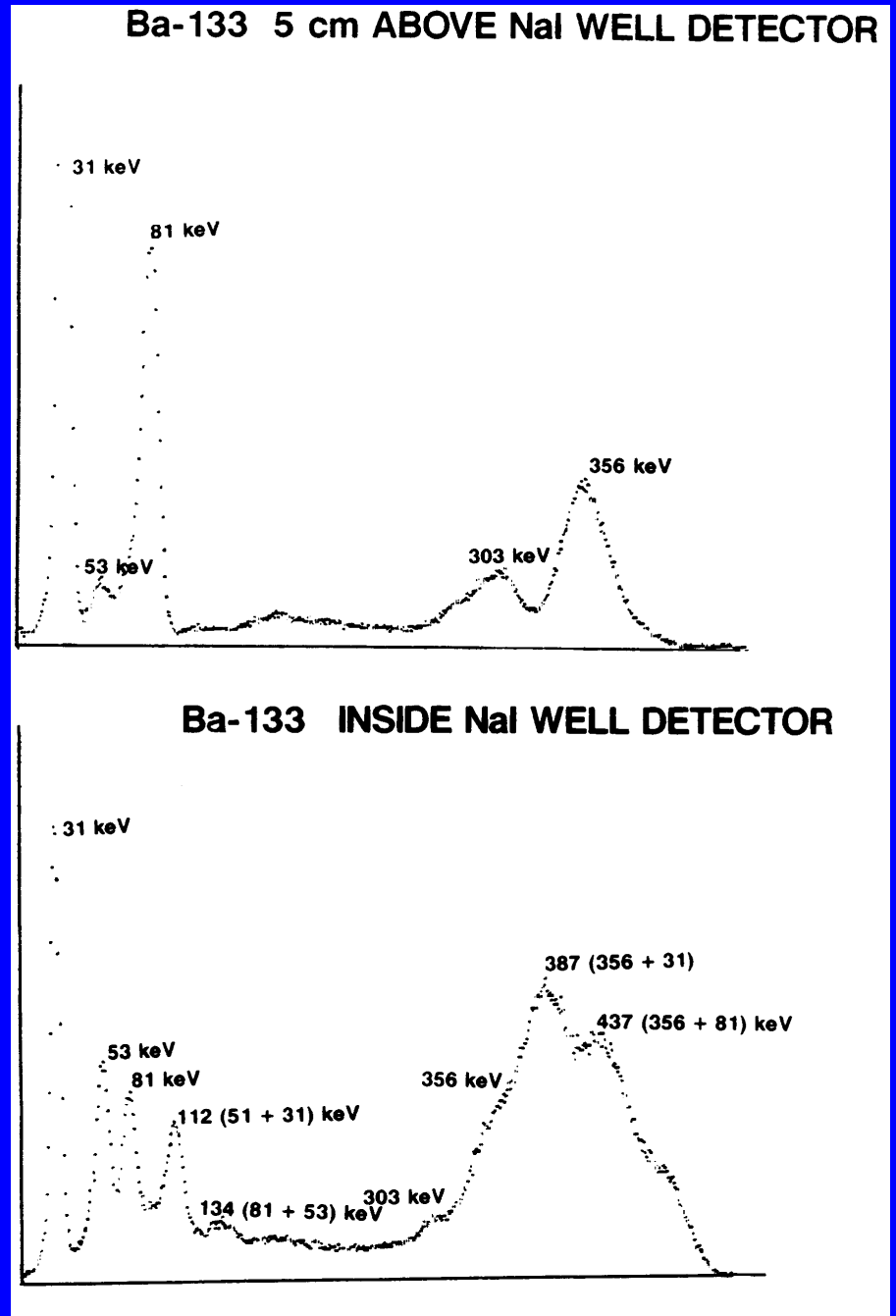

# Coincidence Summing

## True Coincidence

- Gammas produced by positron emitters (e.g., Na-22) are prone to true coincidence because there are two 511 photons per decay.
- A nuclide can be quantified inside a well detector if the counting efficiency was determined for that nuclide with the standard source inside the well.

Na-22 5 cm ABOVE NaI WELL DETECTOR

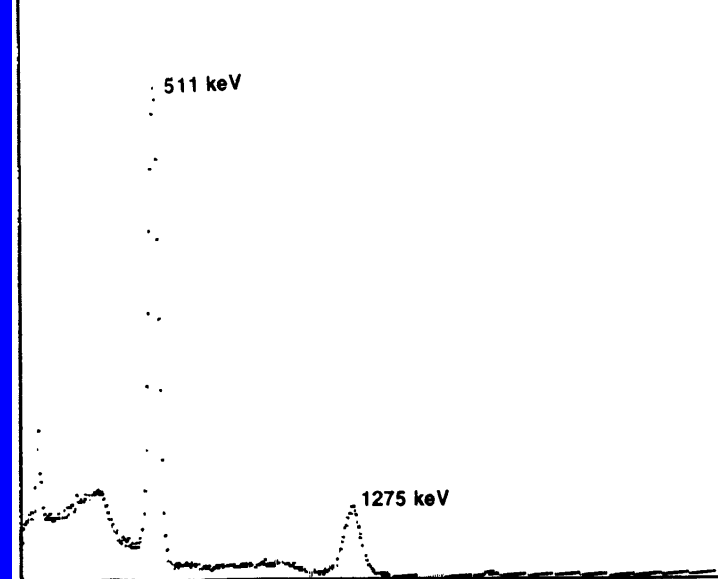

Na-22 INSIDE NaI WELL DETECTOR

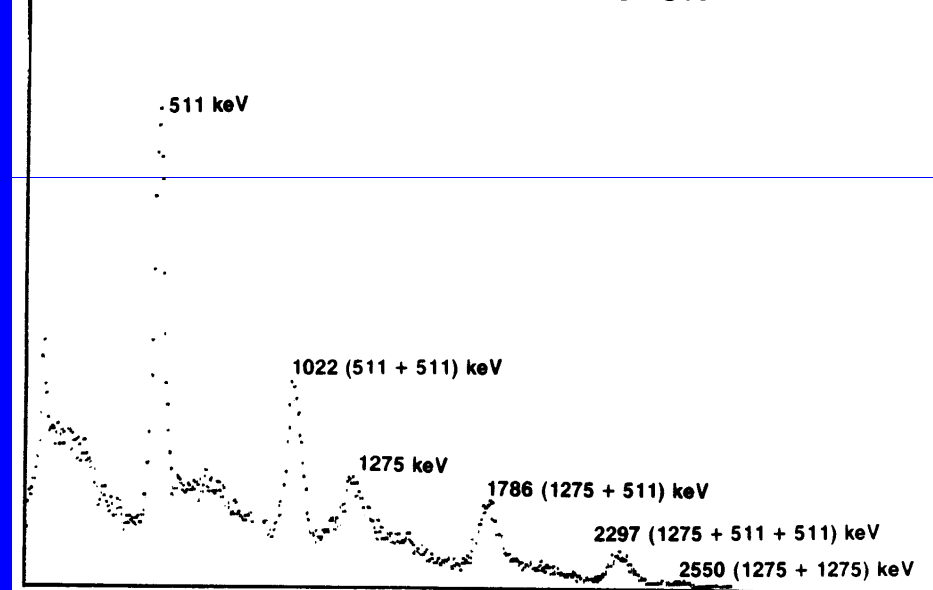



# Coincidence Summing

## Random Coincidence

- Random (or chance) coincidence occurs when the two coincident photons were emitted by the decay of separate atoms.
- If a radionuclide emits a single photon per decay (e.g., Cs-137), only random coincidence is possible.
- The probability of random coincidence increases as the count rate increases.
- Random coincidence can be reduced by moving the sample farther away from the detector - this reduces the count rate.

# Coincidence Summing

## Random Coincidence

- How many sum peaks could result from random coincidence in the case of Co-60?

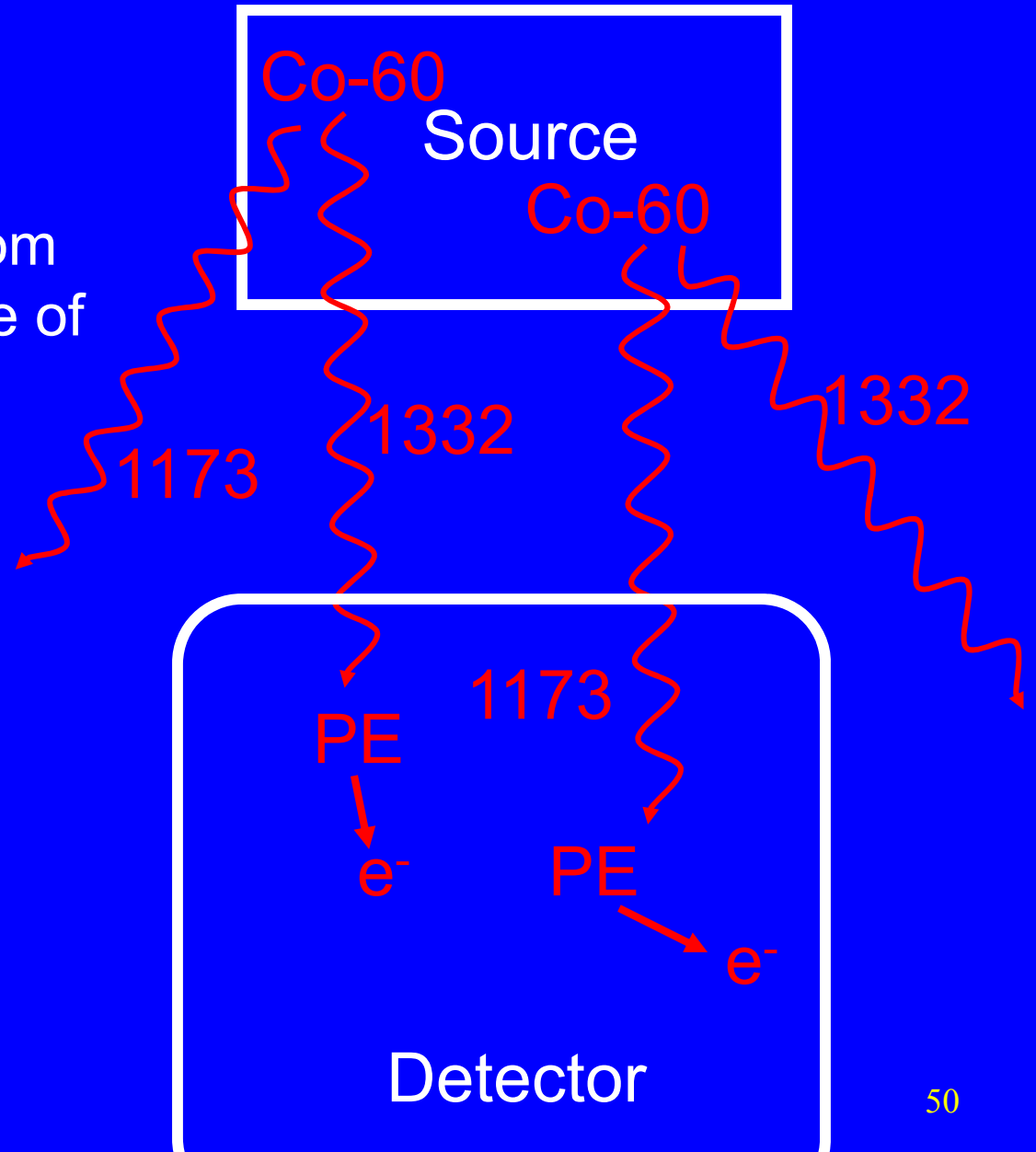

# Coincidence Summing

## Random Coincidence

- How many sum peaks could result from random coincidence in the case of Co-60?

Three

Their energies would be:

$$2346.4 \text{ (} 1173.2 + 1173.2 \text{)}$$

$$2505.7 \text{ (} 1173.2 + 1332.5 \text{)}$$

$$2665.0 \text{ (} 1332.5 + 1332.5 \text{)}$$

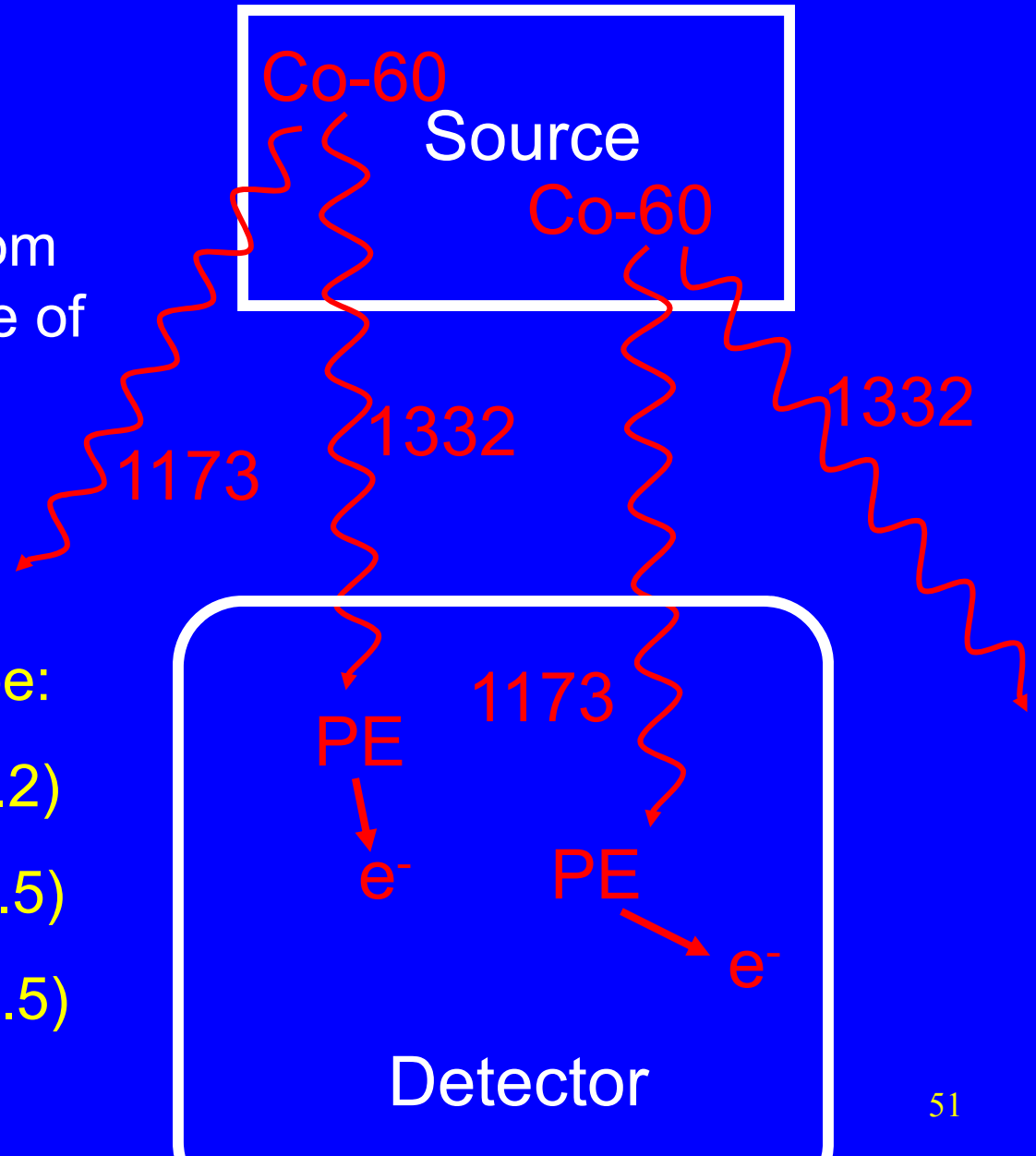

# Bremsstrahlung

# Bremsstrahlung

## General

- High energy beta particles can complicate the spectrum by producing bremsstrahlung.
- Most of the bremsstrahlung pulses will show up towards the left (low energy) end of the spectrum.
- The bremsstrahlung might be produced in the:
  - sample (or sample container)
  - detector housing. This is sometimes prevented by counting with a sheet of plastic (ca 1 cm) between the sample and detector.

# Bremsstrahlung

## General

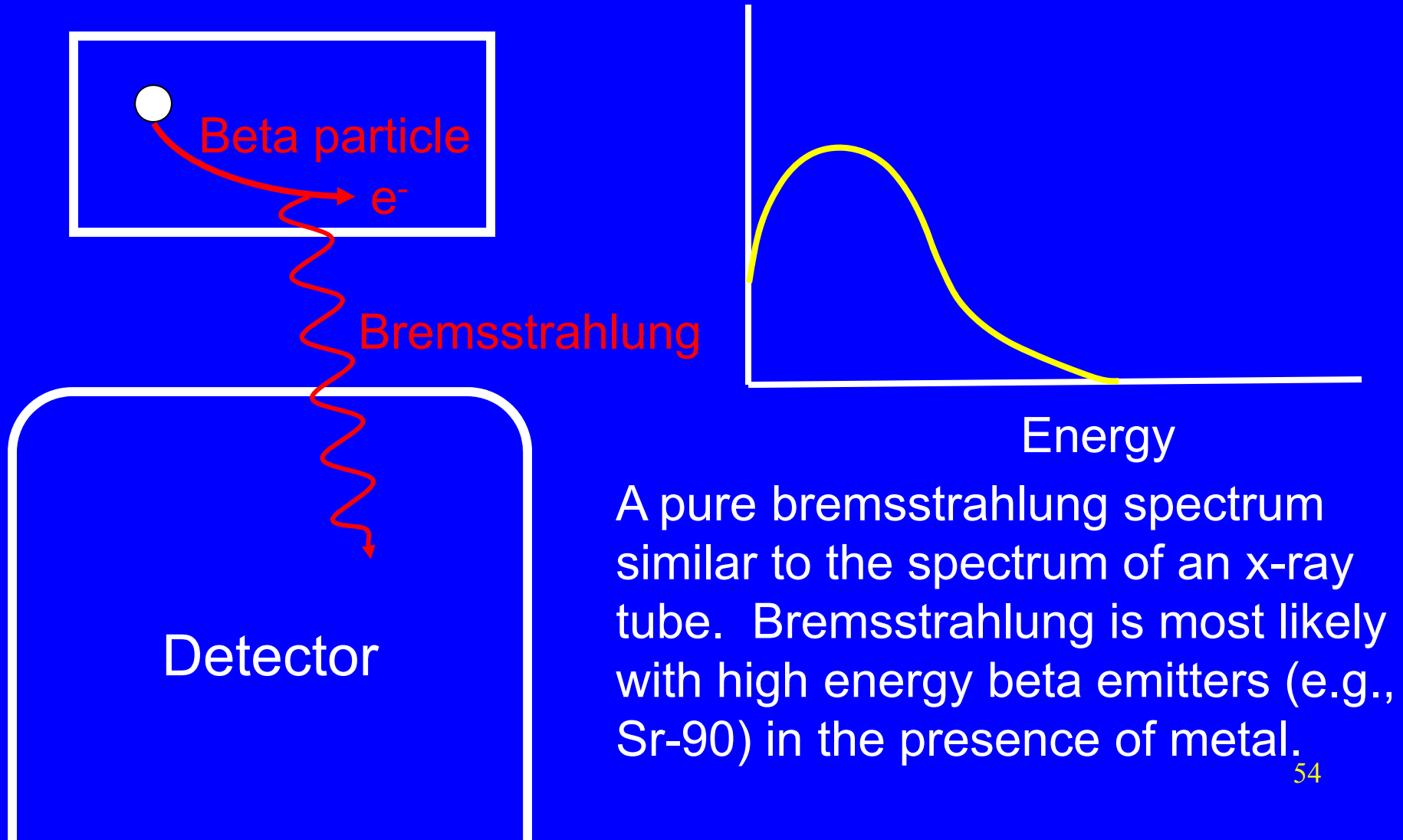

A pure bremsstrahlung spectrum similar to the spectrum of an x-ray tube. Bremsstrahlung is most likely with high energy beta emitters (e.g., Sr-90) in the presence of metal.

# Bremsstrahlung

## General

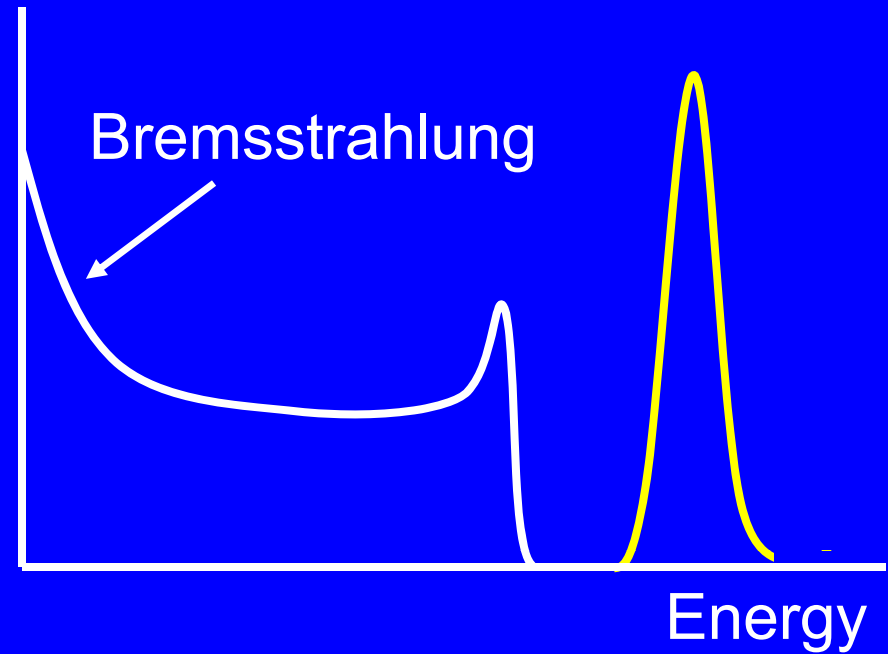
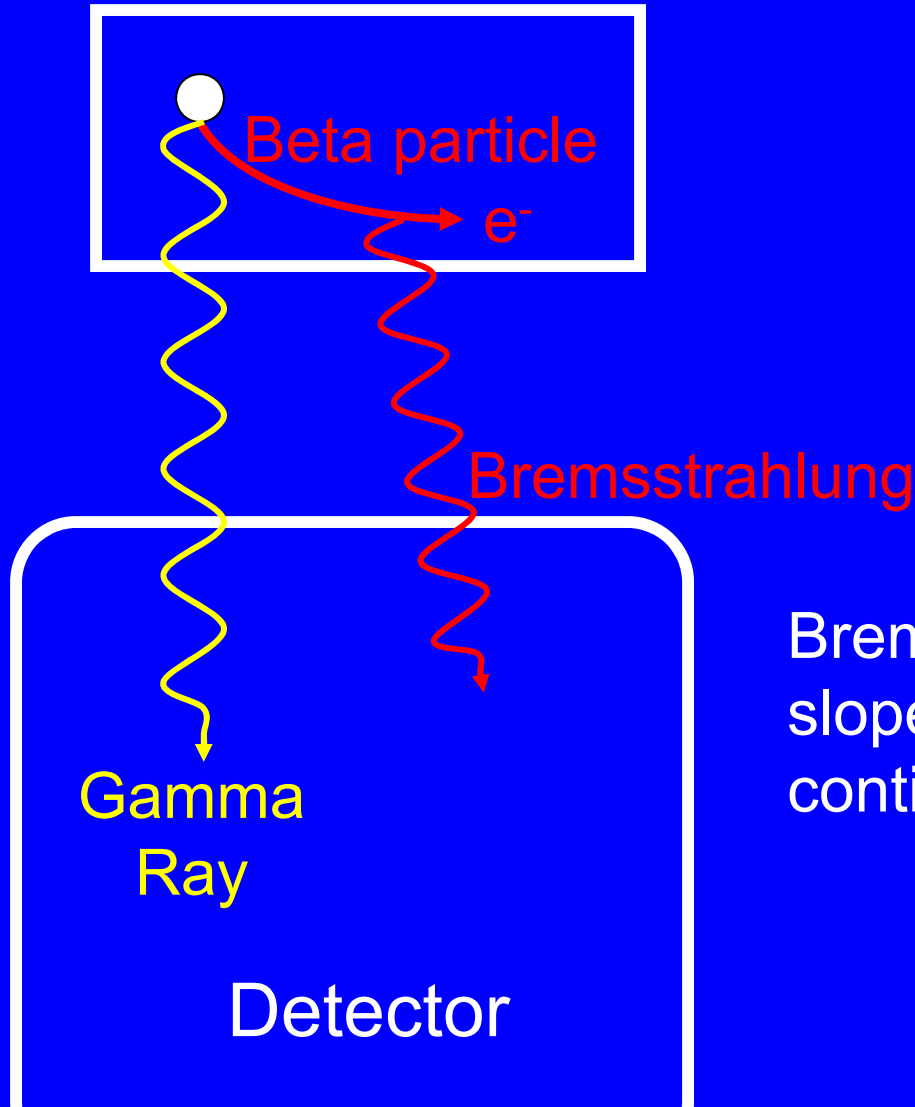

Bremsstrahlung can produce a steep slope on the left side of the Compton continuum.

# Shielded Spectra



# Shielded Spectra

## General

- Material between the source and detector can greatly complicate the analysis:
  - Low energy photons from the source can be completely attenuated (stopped).
  - A greater percentage of the photons reaching the detector will have undergone Compton scattering.
- This is most likely to be a concern when gamma spectroscopy is performed outside of the laboratory

For example, using a hand-held unit to identify radioactive material inside a shipment of scrap steel.

# Shielded Spectra

## Potential Changes to the Spectrum

- Low energy peaks are eliminated.
- All the peaks might be eliminated.
- The valley between the Compton edge and the photopeak disappears because it is filled with forward scattered photons.
- The backscatter peak becomes prominent.

# Shielded Spectra

## Heavily Shielded Spectrum

- In some cases, the shielding might be so severe that no peaks are found on the spectrum.
- Determine the energy on the right end of the spectrum.

This is the energy of the highest energy gamma ray emitted by the source (in this case, the 1332 keV gamma of Co-60).

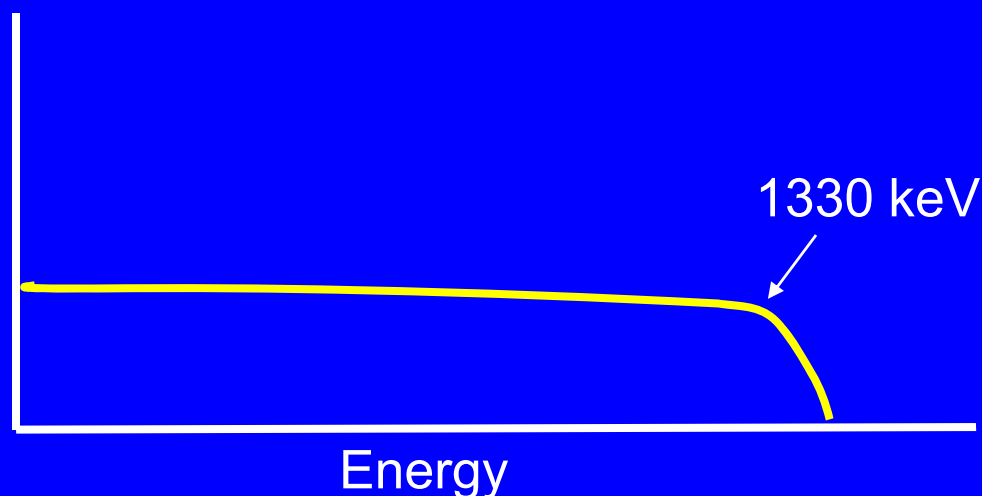

# Shielded Spectra

## Shielded Ra-226 Spectrum

- The next slide shows a shielded Ra-226 spectrum.
- The peak for the most penetrating gamma ray (609 keV) was obscured because the forward scattering produced pulses in the region between the photopeak and where its Compton edge should appear.
- The low energy photons at 186, 242 and 295 keV were sufficiently attenuated that no discernible peaks were present.
- The only clear peak was at 352 keV. That gamma ray had a higher intensity and was more penetrating than those at 186, 242 and 352 keV.

# Shielded Spectra

## Shielded Ra-226 Spectrum

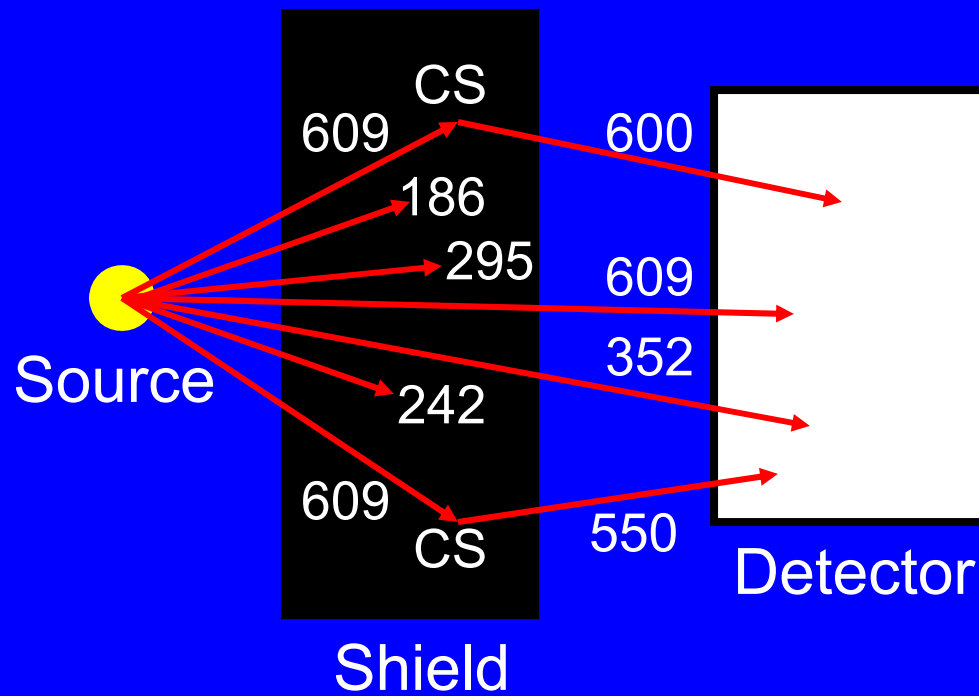

## Spectrum

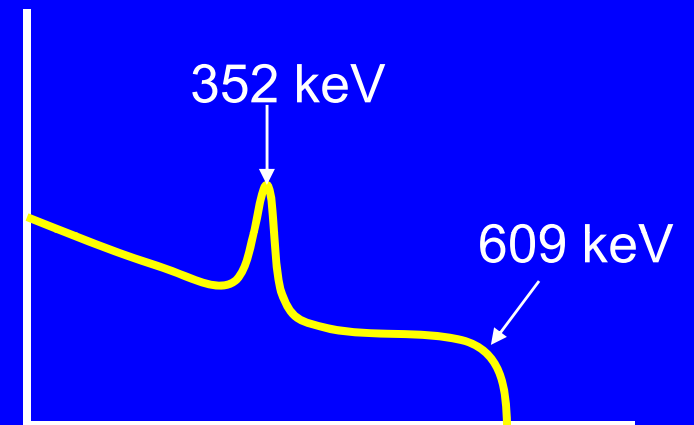

# Shielded Spectra

## Improving a Shielded Spectrum

- When we are faced with badly shielded spectrum we can try analyzing a different side of the source!
- Measure the exposure rates on all sides of the source.

Collect the spectrum on the side of the source where the highest exposure rates were found.

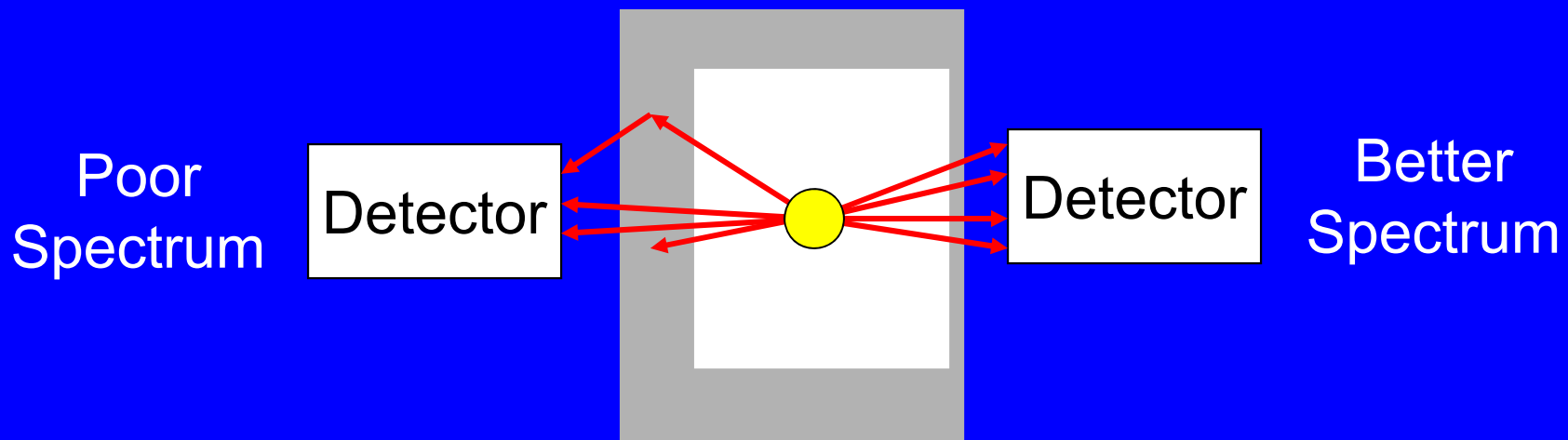

# Shielded Spectra

## Self-shielded Sample

- In some cases, the shielding occurs inside the sample itself.
- This is most likely to be a problem when dealing with low energy photons and large dense samples.
- For example, as seen on the next slide, trying to determine the presence of U-238 via the 63 keV gamma ray of Th-234 can be difficult.

The 63 keV gamma ray is easily attenuated by the sample matrix.

# Shielded Spectra

## Self-shielded Sample

- Due to self shielding the 63 keV peak is not seen in the spectrum to the right. It looks like a purified Ra-226 source.
- You can't tell whether it is purified radium or the entire uranium series.

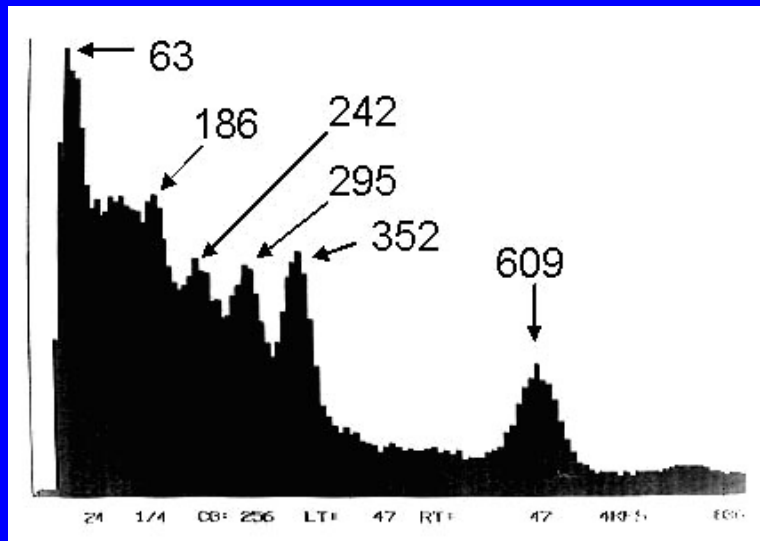

Unshielded NaI gamma spectrum of uranium decay series

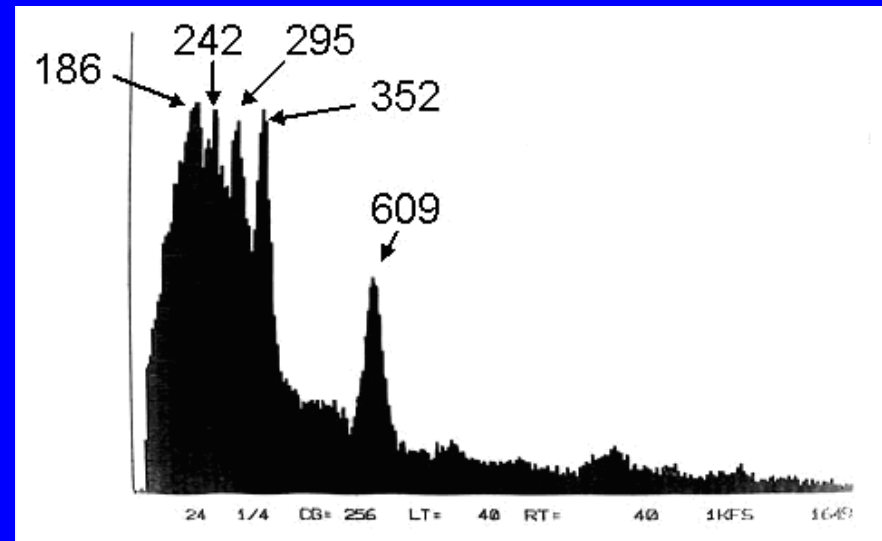

Lightly shielded NaI gamma spectrum of uranium decay series



# Summary

# Summary

<b>Spectrum Feature</b>	<b>Photons from Source Interact in?</b>	<b>Type of Interaction?</b>
Photopeak	Detector	Photoelectric Effect
X-ray Escape Peak	Detector (near surface)	Photoelectric Effect
Compton Continuum	Detector	Compton Scattering
Single and Double Escape Peaks	Detector	Pair Production
Characteristic X-ray Peaks	Shield	Photoelectric Effect
Backscatter Peak	Shield	Compton Scattering
Annihilation Peak (511 keV)	Shield	Pair Production
Summation Peak	Detector	Multiple Photons Interact via Photoelectric Effect in Coincidence